

MuteDesign®

The new **Space S**
phone booth.

Enjoy the silence





Why choose Space S?

Ultra high sound isolation

Space S pod has been developed together with a professional team of acousticians. A well-thought through construction and selection of materials inside its walls and roof make it one of the best performing pod on the market.

Efficient air circulation

A modern and powerful ventilation system allows you to work in comfort for a long period of time. Moreover, the ventilation system of Space S does not create additional noise above the usual sound level in the open-plan office.

Easy installation

Space S pod is shipped in several pre-assembled pieces, packed in a durable case. Installation is easy, and takes max. 90 minutes, so you can quickly assemble it for the first time or move it around the office if needed.

More than a simple Booth, Space S is packed with technological goodness in a meticulously designed construction, where you can be fully connected with the outside world while avoiding its day to day clutter. Its beautiful design & best in class acoustic properties, make Space S a refined symbiosis of style, craftsmanship and performance.



Efficient ventilation & LED light



Phone induction charger



Comfortable stool with adjustable height



Space S

Sublime, ergonomic and functional, Space S provides your office with a peaceful & serene workspace, allowing maximum focus and minimal distraction.

Acoustic function



Isolation

Acoustic performance



Low tones



Mid tones



High tones

Acoustic report

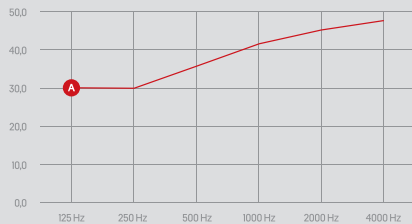

[x] Frequency [Hz] : [y] Sound Isolation [dB]

According to norm EN ISO 140-4:2000



Exterior walls & roof

Metal sheets painted in one of our carefully selected colours, enable high endurance of Space S pod, and give it a premium look.

Door frame

Door frame in a colourful laminate, veneer or premium laminate will match all styles of office interior design.

Construction

A stable construction made of carefully chosen materials allows for quick and easy installation and delivers extraordinary sound isolation.

Interior

Acoustic felt in one of two colour options ensures high sound absorption properties inside the pod, as well as high durability.

Appliances

Thanks to advanced technology built in Space S, such as USB port or induction charger, you will always stay connected.

Exterior Walls and roof Colour

1

STANDARD

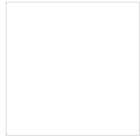

Snow White Matt
RAL 9003



New York Grey Matt
RAL 7042

EXTRA Options

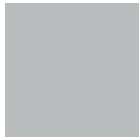

Powder Grey Ultra Matt
RAL 7035



New York Grey Ultra Matt
RAL 7042



Pepper Grey Ultra Matt
RAL 7012



Panther Black Ultra Matt
RAL 9005



Chilli Red Ultra Matt
RAL 3020



Pumpkin Orange Ultra Matt
RAL 2004



St. Tropez Yellow Ultra Matt
RAL 1018



Basil Green Ultra Matt
RAL 6032



Midnight Green Ultra Matt
RAL 6004



Navy Blue Ultra Matt
RAL 5003

Interior Felt

5

STANDARD

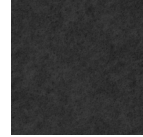

Dark grey



Beige

Interior Stool

4

EXTRA Options



Adjustable stool
Kvadrat Remix2 152



Adjustable stool
Kvadrat Remix2 773



Adjustable stool
Kvadrat Remix2 982

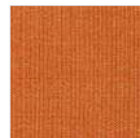

Adjustable stool
Kvadrat Remix2 543



Adjustable stool
Kvadrat Remix2 643



Adjustable stool
Kvadrat Remix2 152



Adjustable stool
Kvadrat Remix2 242



Adjustable stool
Kvadrat Remix2 183

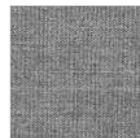

Adjustable stool
Kvadrat Remix2 133

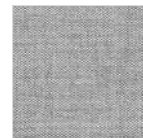

Adjustable stool
Kvadrat Remix2 123

Exterior Frame Finish

2

STANDARD

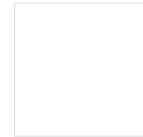

Snow White
NCS S 0500-N



New York Grey
NCS S 3000-N

EXTRA Options



Powder Grey
NCS 1502-G



Panther Black
NCS S 8502-B



Chilli Red
NCS 1085-Y8R



Pumpkin Orange
NCS S 0585-Y70R



Basil Green
NCS S 3060-G10Y



Navy Blue
NCS S 7020-R80B



Ash Veneer



Oak Veneer



Walnut Veneer



White premium laminate



Black premium laminate

Equipment

STANDARD

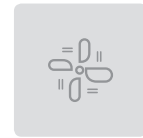

Ventilation system



LED Light



Occupancy sensor



Electric socket **

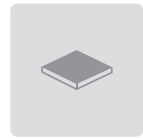

Dark grey carpet

EXTRA Options



USB
built in table **

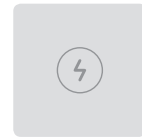

Phone induction charger
built in table **



LAN Connection
Incl. 75m LAN cable

* Standard electric socket Schuko EU. Other electric standards available. Selection must be highlighted in the order.

** Electric socket and USB available in black. White induction charger specified only with tabletop in white laminate. Otherwise a black induction charger is specified. In case of other choice, please highlight in the order.

Dimensions

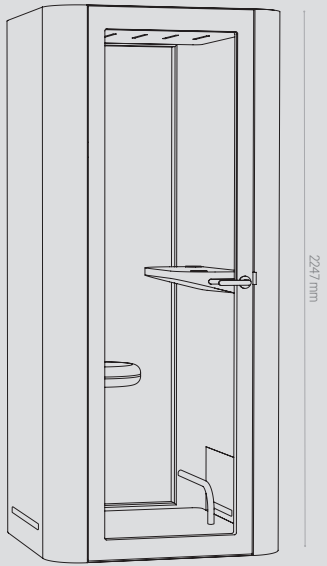

2247 mm

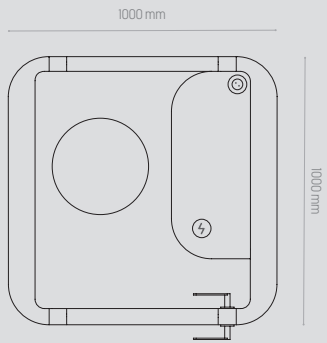

1000 mm

1000 mm

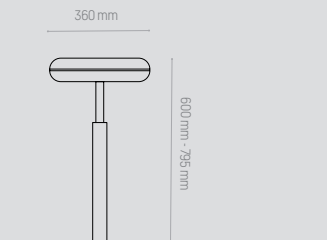

360 mm

600 mm - 795 mm

Weight 350 kg

Configuration examples

MuteDesign®



Example 1

Exterior - Metal Walls Midnight Green Ultra Matt
Exterior - Frame Walnut Veneer
Interior - Stool Fabric Remix2 852



Example 2

Exterior - Metal Walls Chili Red Ultra Matt
Exterior - Frame Chili Red
Interior - Stool Fabric Remix2 643



Example 3

Exterior - Metal Walls St. Tropez Yellow Ultra Matt
Exterior - Frame Oak Veneer
Interior - Stool Fabric Remix2 242



Example 4

Exterior - Metal Walls Powder Grey Ultra Matt
Exterior - Frame Powder Grey
Interior - Stool Fabric Remix2 123



Example 5

Exterior - Metal Walls Panther Black Ultra Matt
Exterior - Frame Ash Veneer
Interior - Stool Fabric Remix2 242



Example 6

Exterior - Metal Walls Basil Green Ultra Matt
Exterior - Frame Basil Green
Interior - Stool Fabric Remix2 982



Example 7

Exterior - Metal Walls Pepper Grey Ultra Matt
Exterior - Frame Ash Veneer
Interior - Stool Fabric: Hoker Remix2 183



Example 8

Exterior - Metal Walls Pumpkin Orange Ultra Matt
Exterior - Frame Pumpkin Orange
Interior - Stool Fabric Remix2 543

RADIUS
OFFICE

info@radiusoffice.com
www.radiusoffice.com