

Seating

Contents:

Paralel - 2

Ismo - 8

Ulti - 12

Ultra - 20

Baltic - 26

Baltic 2 - 36

Shila - 44

New School - 48

Afi - 56

Team - 62

Artiko - 66

Agora - 72

Grace - 78

Grace chair / high stool - 84

Fat Frank - 90

Stilt - 94

Mesh - 100

Kaiva - 106

Mix - 110

Pental - 114

Shape - 118

Bazalto - 122



Paralel

by Yonoh Studio

With Paralel, Yonoh Studio wanted to create a whole new collection of versatile and organic seating that wraps comfortably around the user's body.

This simple, yet difficult to achieve concept, is accomplished thanks to the perfect balance of form and function. The most interesting feature of Paralel armchairs is the way the backrest unfolds around the user, thus creating a more intimate and natural space around them. This was inspired by leaves growing from a branch.

The easy and minimalistic lines of the seat match with the raw, industrial-like modern base in a few versions. The backrest is also customisable; depending on the preferences, it can be selected amongst two heights: low chair-like, or higher version, typical for an office chair. With the armrests, possibilities grow even more. With so many options regarding both the structure and the finishing, it is a real journey through parallel realities. In all versions, it will be an unmissable touch for the modern executive office.







PR2P21
670 / 670 / 960
26 3/8" / 26 3/8" / 37 7/8"



PR1P21
670 / 670 / 790
26 3/8" / 26 3/8" / 31 3/8"



Ismo

by Krystian Kowalski

Classical form, soft outline, sleek base and comfortable cushions are the essential features of the Ismo armchair.

Ismo is perfect for lounge zones, living rooms, libraries and for meetings, leisure and relaxation. Compact size makes it a great choice for residential and cosy interiors.

The untypical wide seat is supported on a sleek piping base, that hugs its backrest. Those contrasting parts make Ismo a modern and at the same time nostalgic piece of furniture.

Its timeless, uncompromised design balances comfort and style. Soft lines of the wide seat invite the User to sit back and relax, and wrap around them gently.

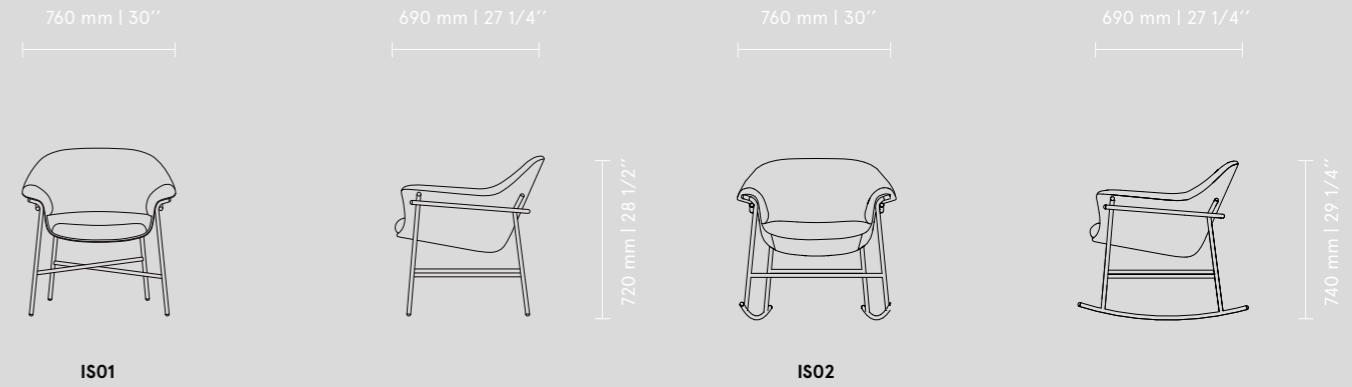



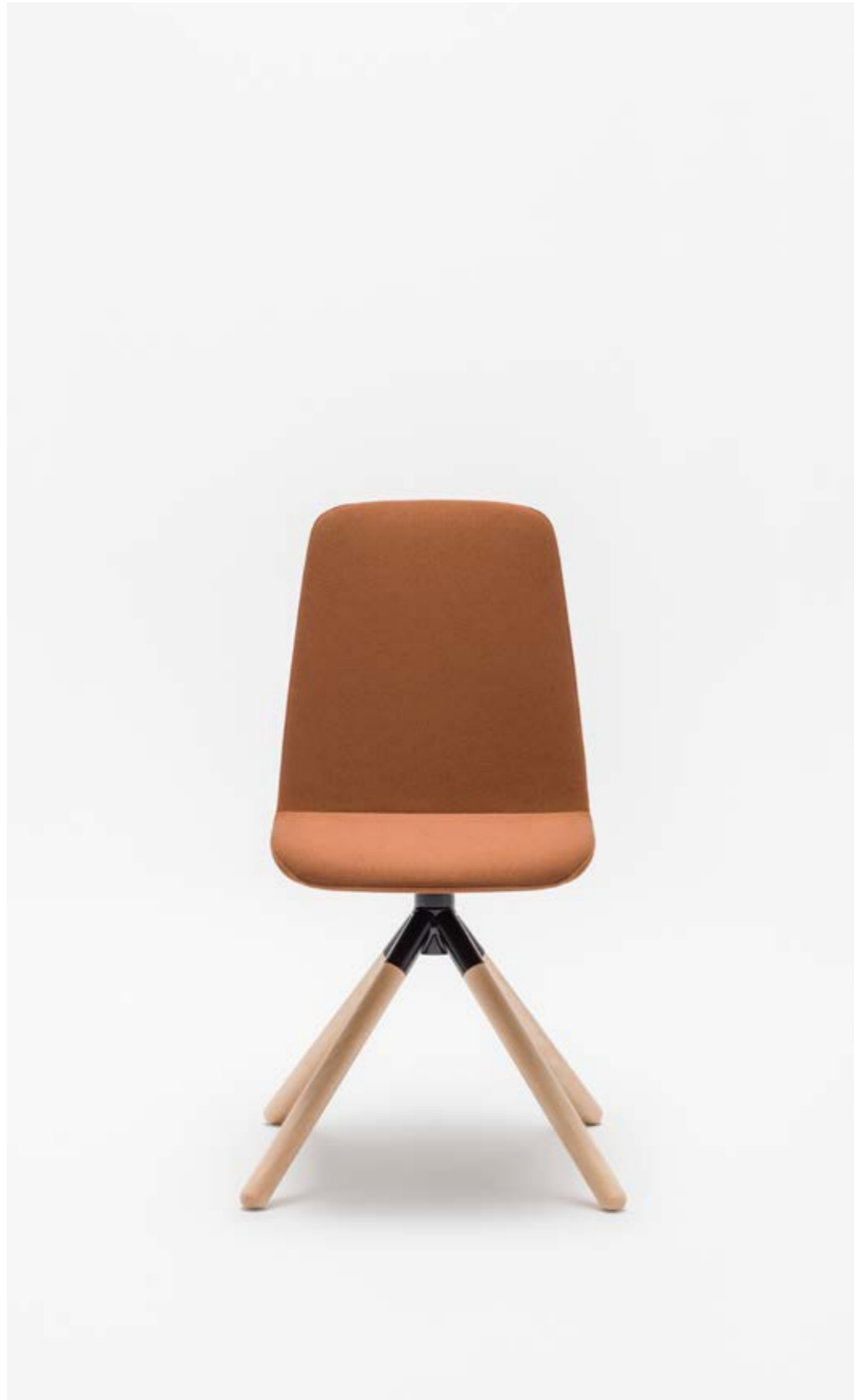

Ulti

by Krystian Kowalski

A combination of minimalist design and high comfort – Ulti sets a new standard for conference chairs.

or glides and armrests as well. Whether with hard-wearing metal base, or wooden one with homely feel, it ensures long-term comfort.

With a wide range of finishes and base options it perfectly adapts to a variety of aesthetics, work styles, and environments — from offices or public utilities to home interiors. Designed to be eye-catching yet functional, the Ulti chair can be provided with castors



480 mm | 19 1/4"

570 mm | 22 3/4"

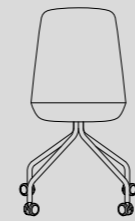

UKP18K



UKP18K



UKP17



UKP16

890 mm | 35 1/8"

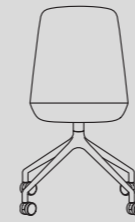

UKP19K



UKP19



UKP9



.mdd

mdd.eu



RADIUS
OFFICE

info@radiusoffice.com
www.radiusoffice.com

.mdd

Ulti



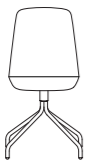

UKP17
 470 / 570 / 884
 18 5/8" / 22 7/8" / 34 7/8"

Ultra

by Krystian Kowalski

Ergonomically-shaped shell seat and numerous metal and wooden base options – Ultra means many solutions.

of uses around your office or even at home — from formal gatherings in conference room to family meetings in dining area.

The most striking feature of the Ultra armchair forms the cushion fastened to its backrest. Designed not only to catch the eye, it provides comfort needed to make sitting a pleasure. Fusing distinctive design and maximum functionality, the Ultra armchair will fit multitude



600 mm | 23 5/8"

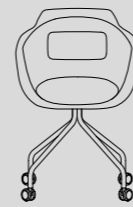

UFP18K

600 mm | 23 5/8"



UFP18K

840 mm | 32 7/8"



UFP17



UFP16



UFP11



UFP11K



UFP19

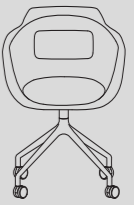

UFP19K



UFP5



UFP15

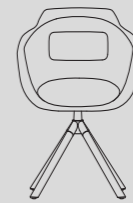

UFP9

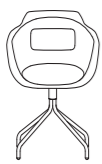

UFP17
 600 / 600 / 840
 23 5/8" / 23 5/8" / 32 7/8"





Baltic

by Krystian Kowalski

The Baltic chair is the representation of versatility and comfort expressed through meticulously outlined shell form that is embedded on thoughtful and elegant bases.

The strive for perfection resulted in constructing a multifunctional family of chairs that please the user with cosiness regardless of the setting. Being abundant with options, the Baltic chair can serve numerous purposes in both commercial and residential use.

Work, dining, relaxation, outdoor – the Baltic grants a freedom of choice. Various types of bases, each manufactured using different technology, serve

diverse purposes while preserving the same concept of a cosy shell chair. In spite of shuffling between different aesthetic approaches of classic four-legged, unconventional four-spoke with or without castors, and traditional wooden base, the Baltic chair never loses its distinctive character. The sensation of comfort is built up by adding a soft cushion upholstered in the finest quality fabrics from renowned European brands.

The Baltic chair is no shy when it comes to minimizing the impact on the environment. Both metal and wooden components are well known recyclable materials that can be reprocessed multiple times.

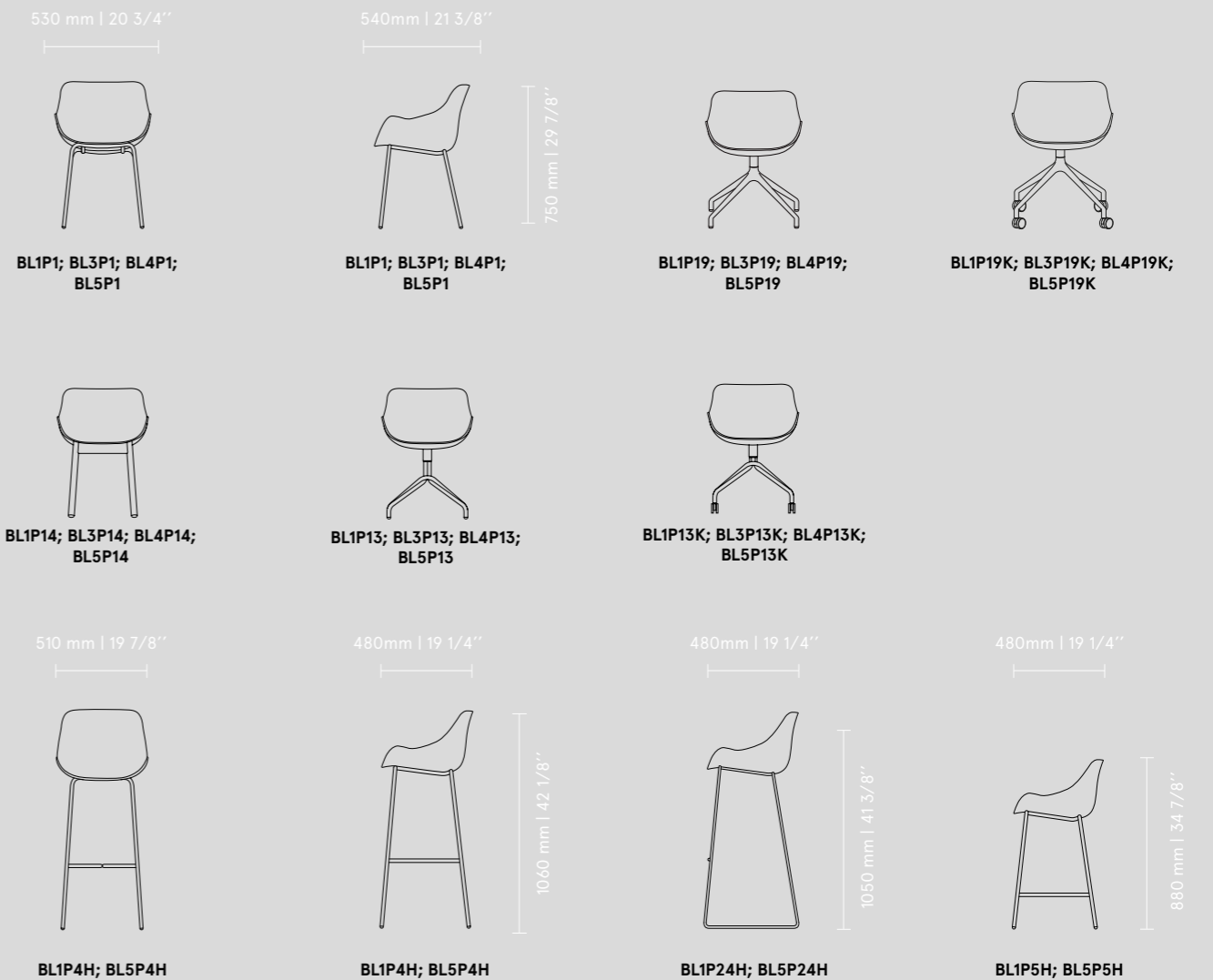



.mdd

mdd.eu

RADIUS
OFFICE

info@radiusoffice.com
www.radiusoffice.com



.mdd

Baltic

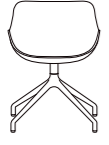

BL5P19
530 / 540 / 750
20 3/4" / 21 3/8" / 29 3/8"





BL4P14
 530 / 540 / 760
 20 3/4" / 21 3/8" / 30"





Baltic 2

by Krystian Kowalski

Using timeless materials and universal forms, Krystian Kowalski has created a multi-generational chair – durable and indifferent to the changes in trends.

The designer returned to the Baltic family with the no-armrests version. In this form, the chairs are even more versatile – great for offices, homes and public interiors, especially gastronomy facilities and lounge zones. Its upholstered seat and simple 4-legged base (in metal

or wood) make the chair exceptionally comfortable, regardless of the context and the function assigned to it. The upholstered cushion allows the user to lean back and relax. As the rest of the models in the family, Baltic 2 Classic is made of recyclable materials, that can be repurposed and reused. And as all the other seating in the collection, this one is durable enough to withstand years and even generations of use.

450 mm | 17 3/4"

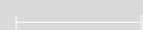

BLK4P1; BLK5P1

540mm | 21 3/8"

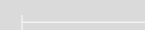

BLK4P1; BLK5P1

760 mm | 29 7/8"



BLK4P13; BLK5P13



BLK4P13K; BLK5P13K



BLK4P14; BLK5P14

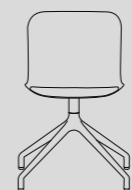

BLK4P19; BLK5P19



BLK4P19K; BLK5P19K



ppw

mdd.eu

RADIUS
OFFICE

info@radiusoffice.com
www.radiusoffice.com

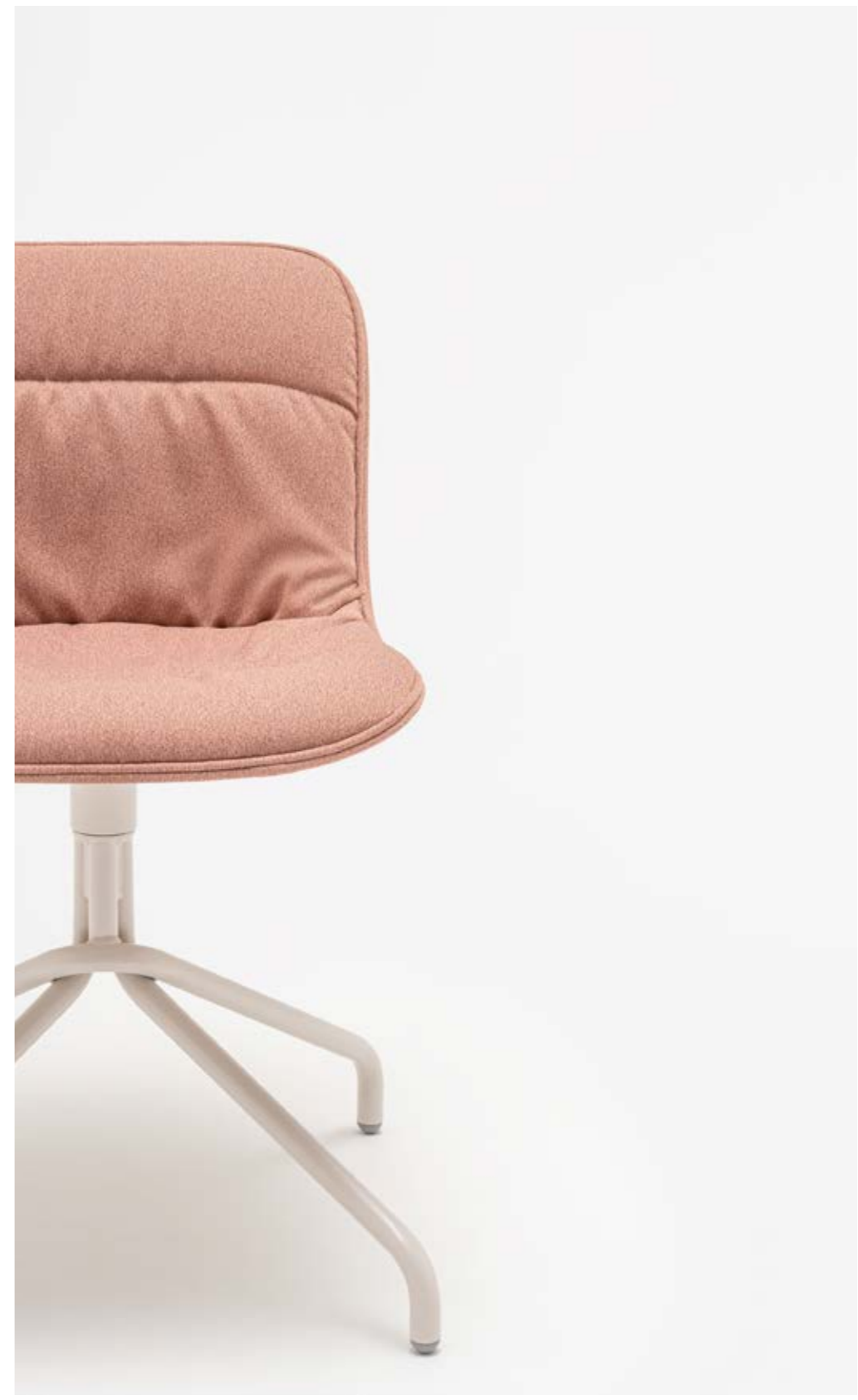

Baltic 2

.mdd



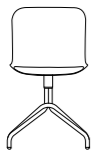

BLK4P13
 450 / 540 / 760
 17 3/4" / 21 3/8" / 30"



Shila

by Javier Cuñado

Offering multiple choices, Shila is a chair that adapts to you.

It's a flexible solution provided in a simple form. Inspired by an idea to meet both office and contract market, this collection offers numerous customisation options including a series of bases, optional armrest and seat cushion. Not only does Shila serve as a guest chair, but also can be a bench with comfortable table top.

All that is available in a subdued colour palette that adds style to any space. Designed to create and elaborate "new efficiency" at work, this seating line promotes motivation, collaboration, movement and dynamism.

590 mm | 23 2/8"

590 mm | 23 2/8"

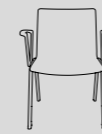

SHS01 with armrest

615 mm | 32 1/8"



SHS01



SHS01

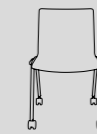

SHS01K

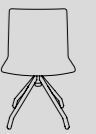

SHS07



SHS07K



SHS10



SHS10K

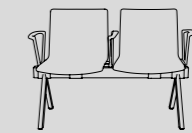

SH2S



SH2S

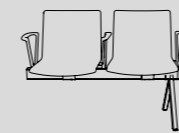

SH2SR

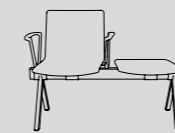

SH1S1B

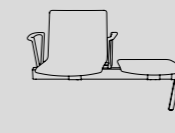

SH1S1BR

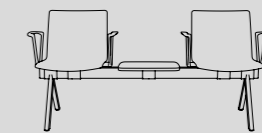

SH2S1B

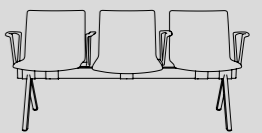

SH3S

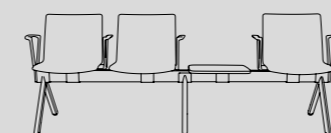

SH3S1B

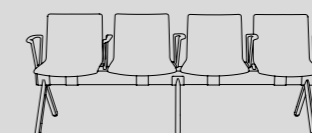

SH4S





New School

by Form Us With Love

To create opportunities through small means, it offers a vast number of combinations tailored to the way you want it.

Find possibilities within its humane and simple construction to make a complete range of typologies for the kinds of activities happening today within the many spaces from cafe to home and office. Growing on the classic school chair, New School provides

a range of options available to meet the varied ergonomic requirements of modern office environment – add castors for mobility, headrest for increased comfort or choose an option with armrest to support a range of arm postures.



458 mm | 18"



N1N01

817 mm | 32 1/8"

535 mm | 21 1/8"

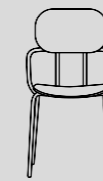

N1N01 with armrest

820 mm | 32 1/8"

535 mm | 21 1/8"



N2N01

1190 mm | 47 1/8"

603 mm | 23 6/8"



N2N03K



N1N03K



N1N03K with armrest

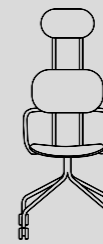

N2N03K

990 mm | 39 1/4"

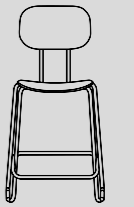

N1N04H

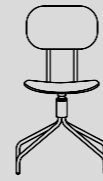

N1N07

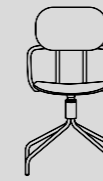

N1N07 with armrest



N2N07

1170 mm | 46 3/8"

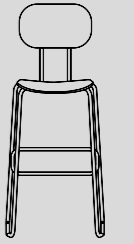

N1N05H



N1N08K



N1N08K with armrest

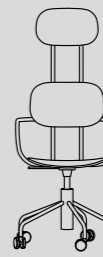

N2N08K



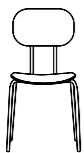

N1N01
 458 / 490 / 820
 18" / 19 3/8" / 32 1/8"





Afi

by Gudmundur Ludvik

Designed with utmost attention to details and manufactured with the finest craftsmanship – AFI is the ultimate answer to a versatile chair and stool.

Its adaptiveness to the specificity of the surroundings makes it an obvious pick for hotels, medical centres, restaurants, offices, but also residential and public spaces. The backrest was designed with comfort in mind. Embracing the user in a delicate grip, AFI ensures

a stable sitting position. The powder-coated black matte finish of the frame helps AFI seamlessly blend with any interior and emphasises its exquisite shape. Both the seat and the backrest are made of veneer plywood available in two subdued shades of oak. AFI conveys the concept of minimalism supported by the high-quality materials making its affiliation with the Scandinavian design by no means accidental.

570 mm | 22 3/4"

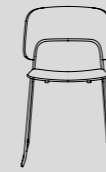

AF04

800 mm | 31 4/8"

530 mm | 20 7/8"



AF05

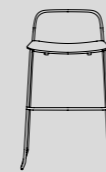

AF06

810 mm | 32 1/8"

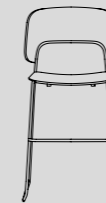

AF07

1000 mm | 39 3/8"

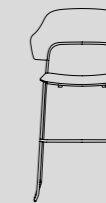

AF08

1000 mm | 39 3/8"

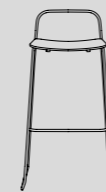

AF01

910 mm | 35 5/8"

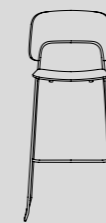

AF02

1100 mm | 43 1/2"

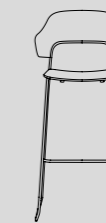

AF03

1100 mm | 43 1/2"





AF01
 484 / 479 / 910
 19 1/4" / 18 5/8" / 35 5/8"

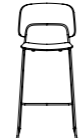

AF02
 492 / 496 / 1100
 19 3/8" / 19 3/8" / 43 1/2"

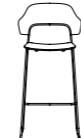

AF03
 567 / 530 / 1100
 22 1/4" / 20 3/4" / 43 1/2"



Team

by Dirk Winkel

A versatile collection of furniture for the home, commercial, and office use.

Constituting of a chair and high stool, Team is a range of consistent design and coherent solutions. Dirk Winkel, the designer behind the Team project, was driven by

his passion for geometrical purism. Such an approach allowed him to create a form that immediately adapts to the interior arranged in any given style. .mdd and Dirk Winkel managed to step up the game and find a common language that resulted in the creation of an exceptional collection.

500 mm | 19 5/8"



TE01; TE01F

590 mm | 23 1/2"



TE11H; TE11HF

770 mm | 30 5/8"



TE01H; TE01HF

960 mm | 37 7/8"

1020 mm | 40 1/8"



TE02F

590 mm | 23 1/2"

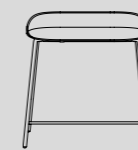

TE12HF

770 mm | 30 1/8"

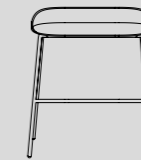

TE02HF

960 mm | 23 1/2"



.mdd

mdd.eu

RADIUS
OFFICE

info@radiusoffice.com
www.radiusoffice.com



Team

.mdd



Artiko

design mdd

The name Artiko correlates to the idea behind the design. In Esperanto, it means "joint", and the series is based on the possibility to freely join differently shaped modules.

It was designed as a collection of slightly rounded elements that can be freely combined. Soft shapes and the lack of sharp edges allow for creating an unlimited number of fluid forms.

Artiko generates a friendly atmosphere in the interior. It favours relaxations and rest, as well as social interactions

– it can be arranged in a way to bring people together or designate niches for them.
 Backrests and practical add-ons – tables and mediaboxes – allow the user to increase the functionality of the seat. Thanks to that, Artiko will be great for public interiors, such as lounge zones in offices, libraries, hotels or universities. At the same time, it will compliment waiting rooms and residential interiors just as well. According to the characteristics of the space, Artiko can be elegant and serious or colourful and funny – you decide.

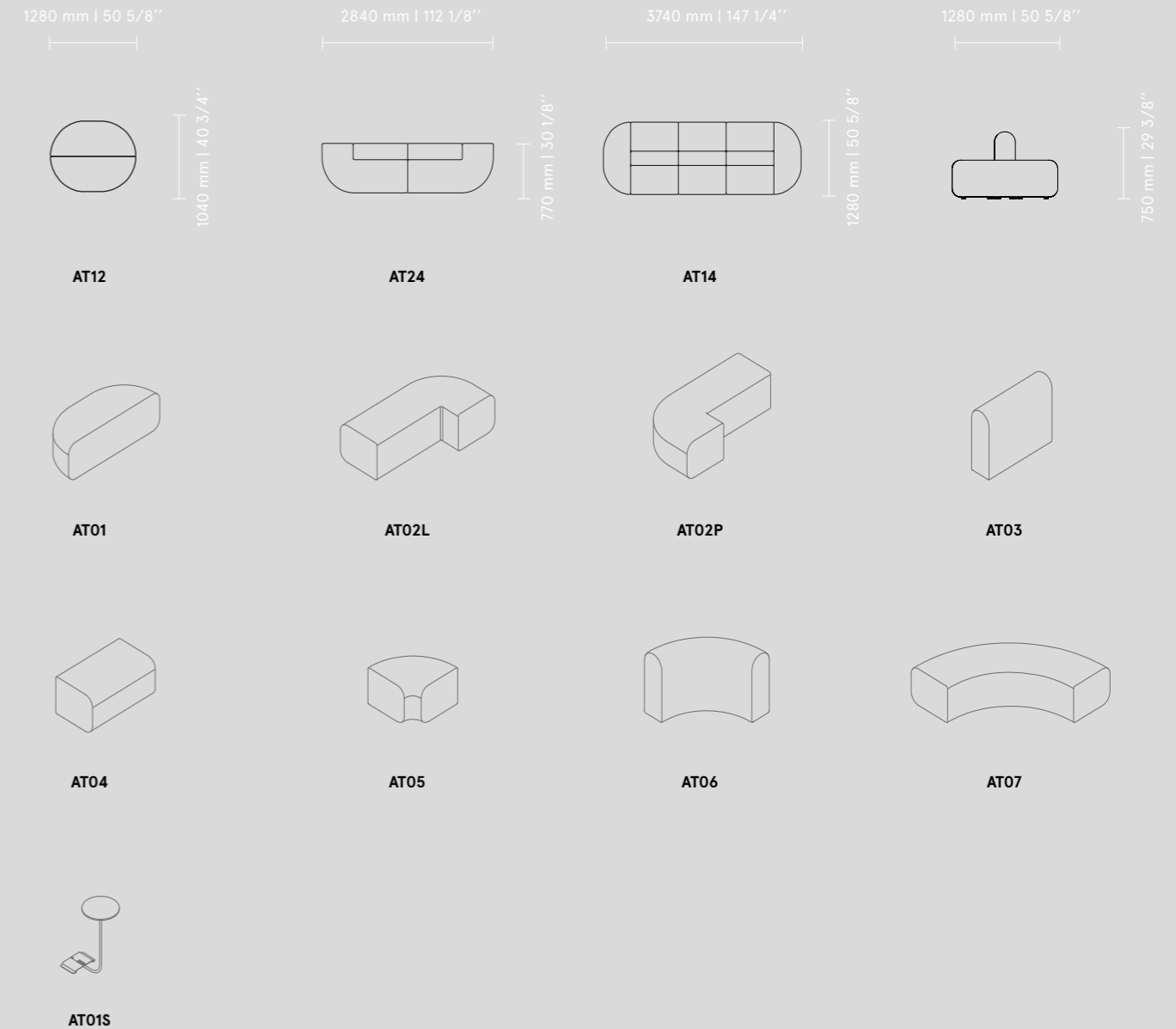



.mdd

mdd.eu



.mdd

Artiko

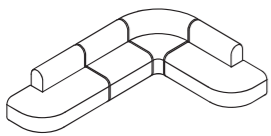

AT08
 AT02L+AT04+AT05+AT02P
 +3xAT03+AT06
 3210 / 2310 / 750
 126 3/8" / 90 3/4" / 29 7/8"



AT12
 2x AT01
 1280 / 1040 / 450
 50 5/8" / 40 3/4" / 17 3/4"



Agora

by Form Us With Love

Being comprised of five elements, it can serve as a bench, a shelf, a sofa or a combination of these units at the same time.

With two seat types, table top and three-tiered shelving unit to choose from, Agora embodies flexibility. Built on tubular structure, it can be as long as you need it to be. Combine these square-shaped units and create any sitting area suited

to the character and size of space arranged – from partitioned meeting point to a place to socialise or to welcome visitors. With original meaning of its name in mind, Agora fosters collaborative behaviours.



610 mm | 24 1/4" 610 mm | 24 1/4"

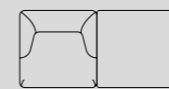

610 mm | 24 1/4"

610 mm | 24 1/4"

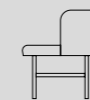

650 mm | 25 5/8"



Bench ES01

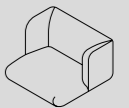

Sofa ES02

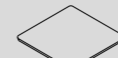
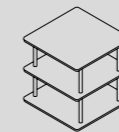

Table ES03



Shelf ES04



AR1K elements to end any configuration

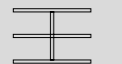

AR1S element to connect separate frame

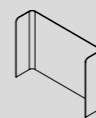

AP01



AP02

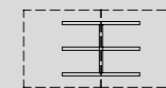

Frame AR01



Frame AR02

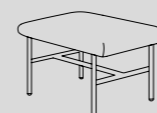

AR10

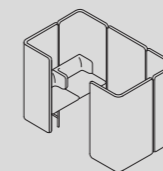

Meeting box AR08B

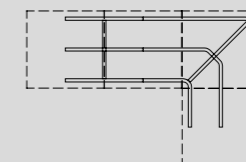

Frame AR04

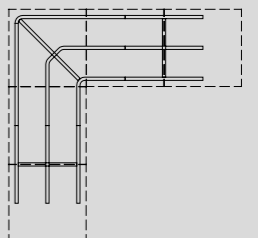

Frame AR05



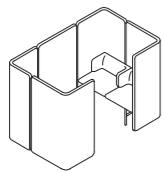

AR08B
 2220 / 1330 / 1500
 87 1/4" / 52 1/4" / 59 1/4"



Grace

by Krystian Kowalski

The Grace furniture family includes sofa, armchair and two tables – featuring sleek design and thoughtful proportions, it graces every room.

Thanks to the combination of distinct seat lines and minimalist frame style it gains a sculptural character. Available in a variety of finishes, this line provides a wide spectrum of arrangement possibilities. That's why not only does the Grace sofa work well in a spacious lobby

of skyscrapers but also in a tiny home office. When combined together, sofas and tables create a lounge area infused with a touch of elegance. Thoughtfully chosen seat materials ensure high comfort of use.



700 mm | 27 4/8"



GR01

760 mm | 29 7/8"

1280 mm | 50 3/8"

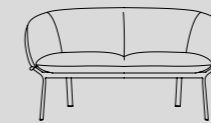

GR02

1860 mm | 73 2/8"

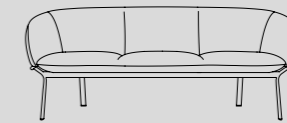

GR03

640 mm | 25 1/8"



800 mm | 31 4/8"



GR01S

440 mm | 17 1/4"

1000 mm | 39 3/8"

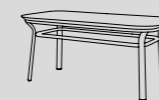

GR02S





GR01
700 / 640 / 760
27 3/4" / 25 1/8" / 30"

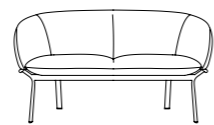

GR02
1280 / 640 / 760
50 5/8" / 25 1/8" / 30"



Grace chair / high stool

by Krystian Kowalski

The chair and stool from the Grace collection is an elegant add-on to the workplace, reception, bar areas, waiting rooms or relaxation zones.

Classic style, distinctive design and a wide range of bases allow creating a chair that will meet the preferences and requirements of the user. The seat with a four-spoke base, available with or without castors, will add an interesting touch to the home office environment while providing maximum comfort of use. The variant with an upholstered leg is an option for less formal zones

in the office whereas the one with the tubular base will perfectly fit in spaces with a loft and industrial character.

Grace stool invites to take a seat for longer. Elegant framework, in two heights, ensures balance and stability, while the abundance of configuration options allows for great adaptability. Grace offers an armchair experience in a high stool edition. The chair and stool is available in a full range of MDD colours and fabrics.

550 mm | 21 5/8"



GRP5

510 mm | 20 1/8"



GRP5

760 mm | 30"



GRP19K



GRP19

550 mm | 21 5/8"



GRP9

550 mm | 21 5/8"



GRP7

930 mm | 36 1/2"

510 mm | 20"



GRP7

550 mm | 21 5/8"

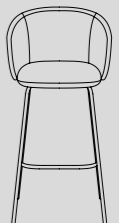

GRP8

1100 mm | 43 1/2"



.mdd

mdd.eu

RADIUS
OFFICE

info@radiusoffice.com
www.radiusoffice.com



.mdd

Grace chair / high stool



GRP8
550 / 510 / 1102
21 5/8" / 19 7/8" / 43 3/8"





Fat Frank

by Krystian Kowalski

Precision of workmanship and maximum comfort of use – the Frank armchair is created in harmony with ergonomics to bring comforts of home into the workplace.

team work- or reception areas. The cushion provided underlines the ergonomics of its design, while tilted seat creates a sense of serenity. Being elegant, it is designed for work as well as relaxation.

The minimalist design provides us with sophistication of large executive armchairs. With two base types to choose from: classic 4-legged or 4-star swivel frame, Frank can be used in a variety of spaces, such as lounge-

690 mm | 27 1/4"

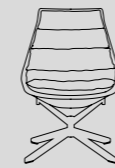

F04

810 mm | 21 1/8"



F04

880 mm | 34 7/8"

400 mm | 15 3/4"



F06

460 mm | 17 7/8"



.mdd

mdd au

RADIUS
OFFICE

info@radiusoffice.com
www.radiusoffice.com



Fat Frank

.mdd



Stilt

by Form Us With Love

Form Us With Love inspired by the steel tubing capabilities of the .mdd factory, witnessed during the New School project collaboration, wanted to take it a step further and build a collection using the same language throughout the entire range.

Stilt is the product of that goal: a collection of superior adaptability that can be used in a wide range of interiors, from the hospitality industry to offices and homes.

The key idea was to develop seating and shelving systems that can allocate space within an area while still being a comfortable and functional part of it.

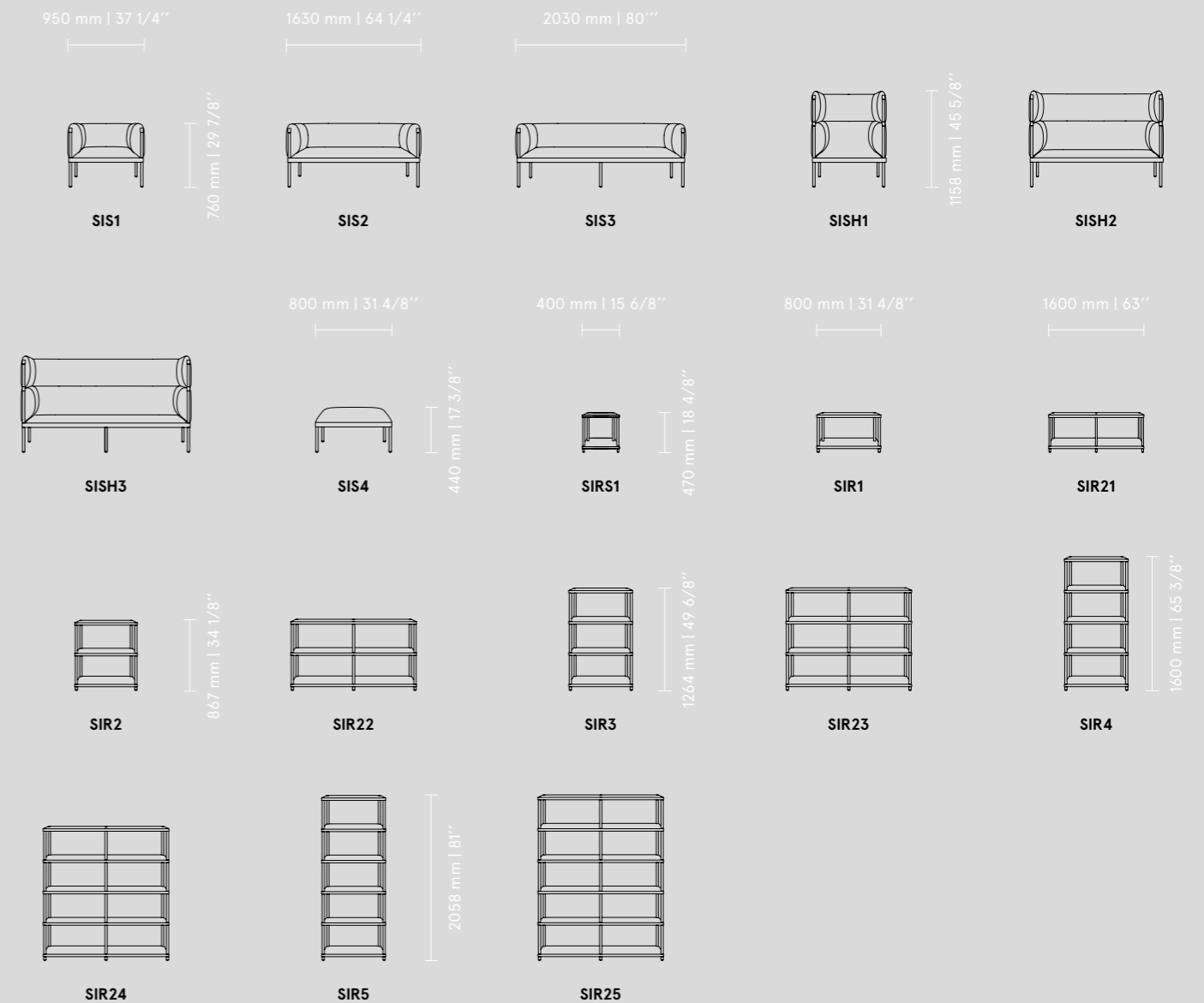

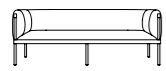

SIS3
2030 / 720 / 760
80" / 28 1/2" / 29 7/8"

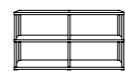

SIR22
1600 / 400 / 867
63" / 15 3/4" / 34 1/4"



SIS1
950 / 720 / 760
37 1/4" / 28 1/2" / 29 7/8"



.mdd

mdd.eu

RADIUS
OFFICE

info@radiusoffice.com
www.radiusoffice.com



.mdd

stilt



Mesh

by Krystian Kowalski

Designed to create friendly office spaces, it can be easily customised to fit a specific space or need.

The Mesh line offers a sofa, an armchair and two tables that bring comforts of home to the workplace. Thanks to its design, it may serve as a place to relax as well as a piece of decoration, and finally as a functional item. The shield available in three sizes becomes the most striking feature of this range – use it to create

a comfortable oasis or a less informal meeting area. Being more than beautifully crafted seating solution, Mesh combines a tailored, craft-based approach with the precision of high-volume technology.





.mdd

mdd.eu



.mdd

Mesh



mdd.eu

Mesh



MF1M
850 / 900 / 900
33 4/8" / 35 3/8" / 35 3/8"



MF1D
1000 / 900 / 1250
39 3/8" / 35 3/8" / 49 2/8"

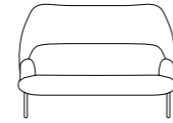

MS1S
1820 / 900 / 1250
71 5/8" / 35 3/8" / 49 2/8"

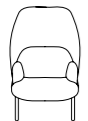

MF1S
870 / 900 / 1250
34 2/8" / 35 3/8" / 49 2/8"

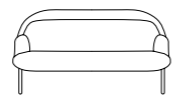

MS1M
1800 / 900 / 900
70 7/8" / 35 3/8" / 35 3/8"

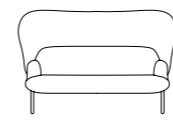

MS1D
1900 / 900 / 1250
74 6/8" / 35 3/8" / 49 2/8"



Kaiva

by Dymitr Malcew

Characteristic form and modular structure – Kaiva is a soft furniture system that allows its users to create their own set.

The line was inspired by an image of stacked stones. According to the concept, various configurations are based on just few elements, that can be freely combined and modified. As its name means conversation in Japanese, Kaiva can serve both as a place of collaborative

work and informal meetings as well as a place of individual focused work. Featuring soft form, touch-friendly fabrics and large colour palette, it introduces positive atmosphere into a workplace. This range can be used in office spaces, hotels, waiting areas and public places.

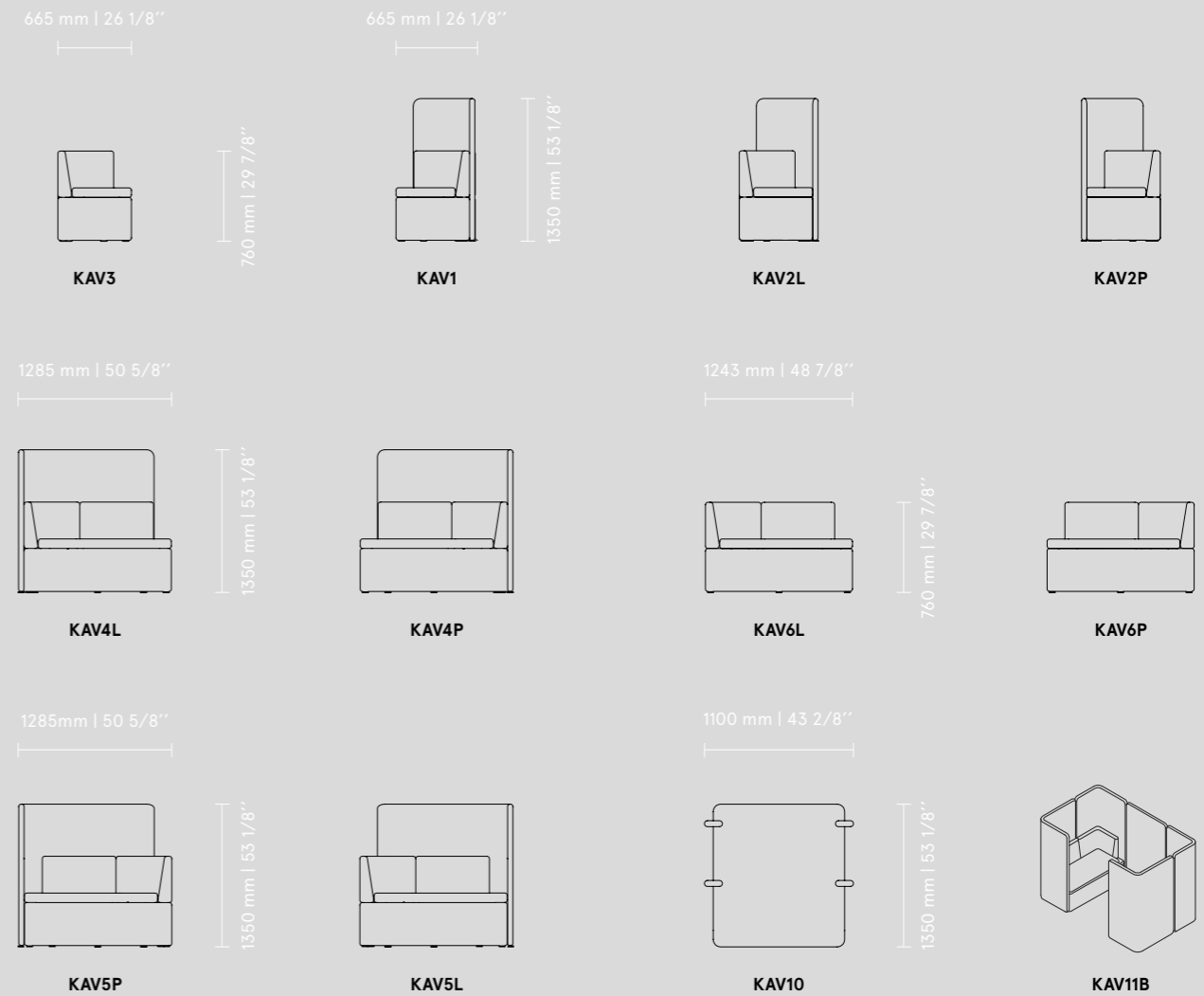



KAV3
665 / 760
26 1/8" / 29 7/8"

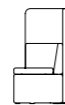

KAV1
665 / 1350
26 1/8" / 53 1/8"

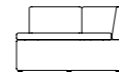

KAV6P
1243 / 760
48 7/8" / 29 7/8"

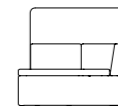

KAV4P
1285 / 1350
50 5/8" / 53 1/8"



Mix

design mdd

MIX is a pouf system of geometric shapes that encourage creativity while arranging the space.

Soft seating is suitable not only for closed relaxation zones but also for open space offices, waiting rooms, reception areas and even home. Available in many

different colours, they will enliven any space in which they are located. Compact furniture is an interesting and functional addition to a modern office. Optional wheels ensure mobility.

430 mm | 16 6/8"

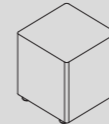

MX01; MX01K

Ø 450 mm | 18"



MX02; MX02K

430 mm | 18"



MX03

460 mm | 18"

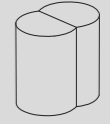

MX04





Pental

by Yonoh Studio

The Pental poufs are the most recent addition to the evolution of classic five-pointed star bases, widely used through the seating furniture history.

Featuring a smooth mesh of interlaced rods, the Pental pouf exhibits the balance of stability and lightness. It is easy to move all around the office (or home) due to its light weight, and at the same time resistant enough to be intensively used by large groups of Users in teamwork

spaces, waiting rooms and during informal meetings. Available in two widths, and in the finest selection of fabrics and colours of the powder-coated base, Pental will seamlessly match any interior, either as a subtle accent or as the main attraction in the setup

Ø 530 mm | 20 3/4"



PTP53

Ø 770 mm | 30 1/8"

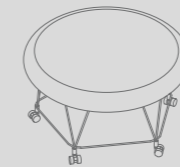

PTP77

430 mm | 17 1/8"

Ø 520 mm | 20 5/8"



PT52

345 mm | 13 5/8"

Ø 520 mm | 20 5/8"

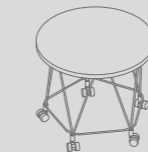

PT520

440 mm | 17 1/8"

Ø 720 mm | 28 1/2"

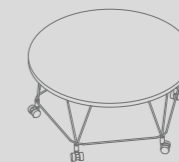

PT72

345 mm | 13 5/8"

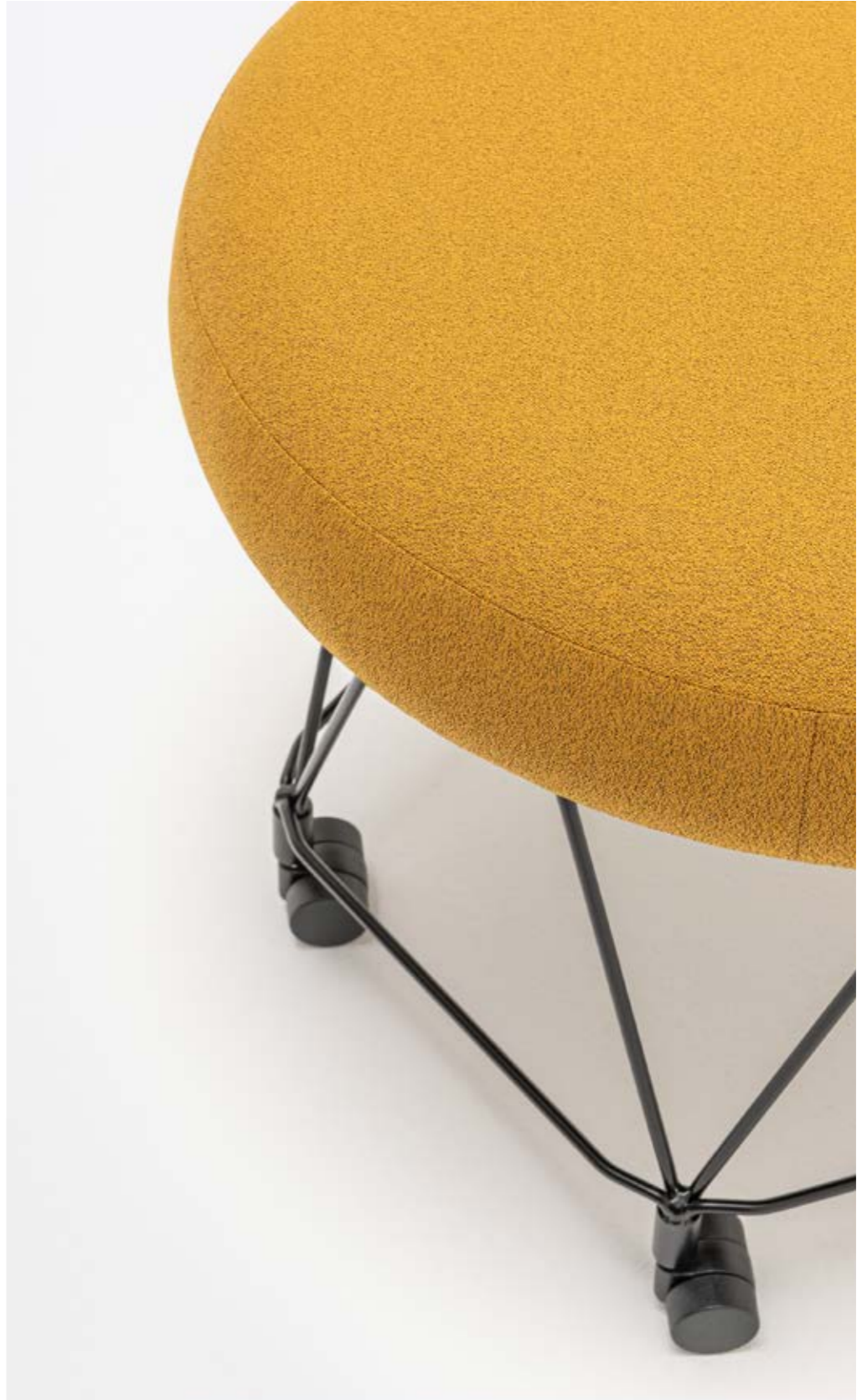



Shape

Ergonomic and extremely comfortable – Shape collection consists of multi-coloured poufs with backrest thanks to which chill-out zones will gain a completely new quality.

This piece of furniture creates friendly and energetic informal spaces. Appearing in several pieces arrangements or separately, the poufs with backrest are

a perfect addition to waiting rooms, social areas, and offices. Shape's spine-friendly and ergonomic design helps to minimize discomfort. By implementing them to larger spaces, it is possible to designate separate areas of various functionality. The pouf provides functionality whereas its abundant colour range introduces freshness and expressive character to the interior.

470 mm | 18 4/8"



SP01

817 mm | 32 1/8"

935 mm | 36 7/8"

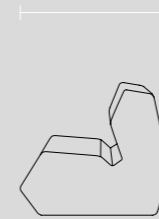

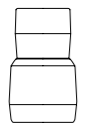

SP01
 470 / 935 / 817
 18 4/8" / 36 7/8" / 32 1/8"

Bazalto

by Andreas Krob

It's a fresh approach to casual seating. The design possibilities are endless and are all up to you.

Inspired by the Giant's Causeway in Northern Ireland, Bazalto is a new, fun and creative way to design a modern seating arrangement for every office space. With a wide array of fabrics in invigorating colours to choose from, it is easy to personalise. Group them to make one large seating piece fostering collaboration or arrange them

separately to create clusters of small units for more privacy. Combine two different heights – the shorter pouf for a seat and the taller one for a backrest – to achieve perfect solution to office seating needs.

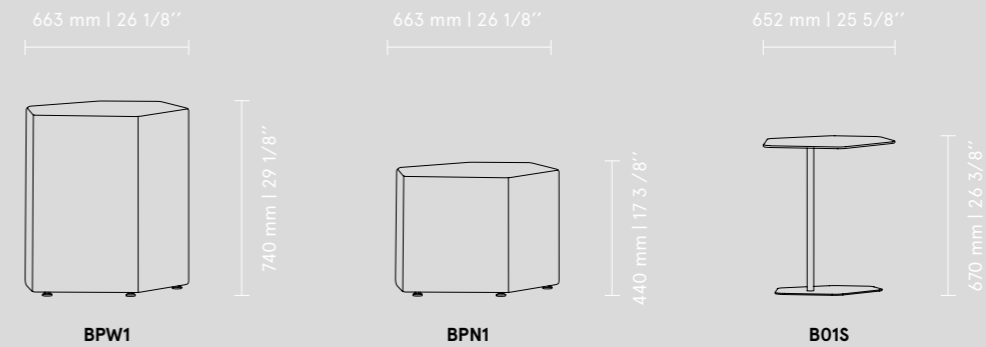



Designers



**Gudmundur
Ludvik**

I am intrigued by the balance between simplicity and complexity. Exploring challenges through multiple perspectives helps me in understanding and reducing them to the core and transforming into simple and intuitive solutions.

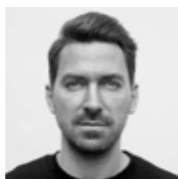

**Dirk
Winkel**

I love exploring new materials and production processes, and I am driven by belief in the beauty of a deeply geometrical formal purism. Careful consideration of every single radius, dimension and proportion of a design is the key to a sustainable formal expression.



**Form Us
With Love**

Good design is a hard question—it's in the eye of the beholder. But if you manage to put a material on the right spot, in both an interior or a product, you come quite for.



**Krystian
Kowalski**

As a hands-on designer my work process combines a full-scale models and prototypes with technology research and advance cad modelling. This methodical approach is focused on revealing the essence of each design. I believe experiencing the product is the only way to develop valuable furniture.



**Javier
Cuñado**

In a smart working environment, each team member should be supported to improve their efficiency.

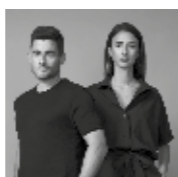

**Yonoh
Studio**

Moved by sensations and intuition, Yonoh stays away from trends in order to stay true to its own voice: the one that keeps creative independence and honesty as its core values.



**Andreas
Krob**

A good office chair should be intuitive in how it's used.



**Dymitr
Malcew**

I'm inspired by things that happen on the periphery and at the intersection of disciplines, cultures and experiences. Regardless of the scale, form or style of the product, designing "experiences" is always the priority. Frame, material and detail is a form of communication with the user.

mdd.eu

RADIUS
OFFICE

info@radiusoffice.com
www.radiusoffice.com