

BuzziTotem

Product Specification Sheet

This document contains technical information about the BuzziTotem

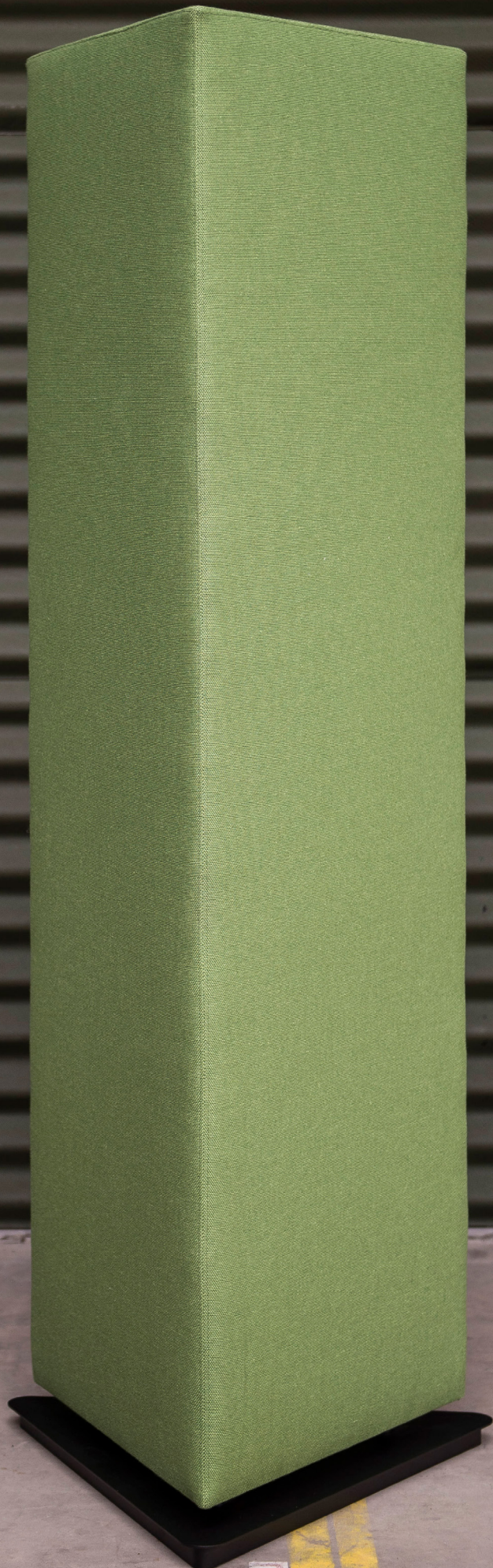

www.buzzi.space



Sculptural, freestanding acoustic pillar

Say hello to this playful, freestanding acoustic pillar, available in three models and a range of 3D statement patterns. No matter the model, the soft edges help diffuse sounds while the upholstered acoustic foam body absorbs sound in its entirety. Needless to say, BuzziTotem is one of our peak acoustic performance solutions. Easily fit this standing, architectural element into corners to trap sound waves in offices, residential settings, or hospitality areas.

Design by BuzziSpace Studio

General

- 📍 BuzziTotem Wedge | Beam | Cylinder
- 🌲 Filling: Acoustic foam + Plywood, MDF, Pinewood
- Pattern: Flat or 3D
- ⋮ Fabrics Flat: Fabric, Trevira CS+ | CS, Revive 1, Clara 2, Remix 3, Velvet, Hero, Tonus 4, Memory 2
- Fabrics 3D: Fabric, Trevira CS+ | CS, Revive 1, Clara 2, Remix 3, Hero, Tonus 4, Memory 2

Acoustics



Absorption



Diffusion



Low tone



Mid tone



High tone

Content

Configurations	3
Patterns	6
Components	7
Fabrics	8
Dimensions	11
Acoustics	17

Configurations

BuzziTotem Wedge Flat

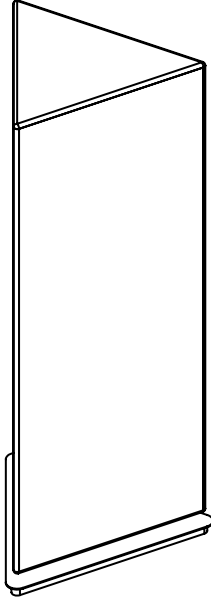

🔑 S|M|L

🌲 Filling: Acoustic foam with Plywood, MDF, Pinewood
Baseplate: powder coated metal or Wood with plastic feet

⊗ **Baseplate**
S: H 120 cm W 62 cm
H 47.24" W 24.41"
M: H 155 cm W 62 cm
H 61.02" W 24.41"
L: H 190 cm W 62 cm
H 74.80" W 24.41"

⚖️ **Baseplate**
S: 10,5 kg | 23.15 lbs
M: 13 kg | 28.66 lbs
L: 15,5 kg | 34.17 lbs

Wood
S: H 116 cm W 55 cm
H 45.67" W 21.65"
M: H 151 cm W 55 cm
H 59.45" W 21.65"
L: H 186 cm W 55 cm
H 73.23" W 21.65"

Wood
S: 8,5 kg | 18.74 lbs
M: 11 kg | 24.25 lbs
L: 13,5 kg | 29.76 lbs

⋮ Fabric, Trevira CS+ | CS, Revive 1, Clara 2, Remix 3, Velvet, Hero, Tonus 4, Memory 2
Color baseplate: Black (RAL 9005)
Optional wheels for metal baseplate only (3 pcs)

BuzziTotem Wedge 3D

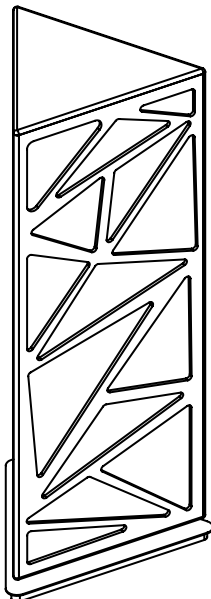

🔑 S|M|L

🌲 Filling: Acoustic foam with Plywood, MDF, Pinewood
Baseplate: powder coated metal or Wood with plastic feet
Pattern: 3D Rib Thin, 3D Rib Thick, 3D Tri

⊗ **Baseplate**
S: H 119 cm W 62 cm
H 46.85" W 24.41"
M: H 154 cm W 62 cm
H 60.63" W 24.41"
L: H 189 cm W 62 cm
H 74.41" W 24.41"

⚖️ **Baseplate**
S: 10,5 kg | 23.15 lbs
M: 13 kg | 28.66 lbs
L: 15,5 kg | 34.17 lbs

Wood
S: H 115 cm W 55 cm
H 45.28" W 21.65"
M: H 150 cm W 55 cm
H 59.06" W 21.65"
L: H 185 cm W 55 cm
H 72.83" W 21.65"

Wood
S: 8,5 kg | 18.74 lbs
M: 11 kg | 24.25 lbs
L: 13,5 kg | 29.76 lbs

⋮ Fabric, Trevira CS+ | CS, Revive 1, Clara 2, Remix 3, Hero, Tonus 4, Memory 2
Color baseplate: Black (RAL 9005)
Optional wheels for metal baseplate only (3 pcs)

BuzziTotem Beam Flat

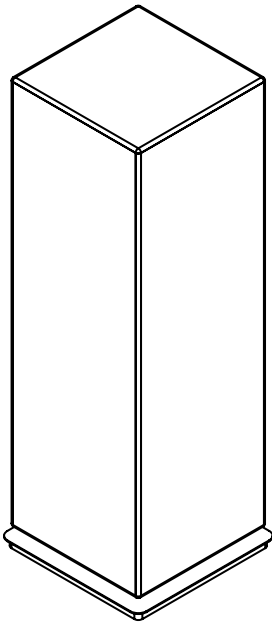

🔪 S|M|L

🌲 Filling: Acoustic foam with Plywood, MDF, Pinewood
 Baseplate: powder coated metal or Wood with plastic feet

	Baseplate	Wood
S:	H 120 cm W 52 cm D 52 cm H 47.24" W 20.47" D 20.47"	S: H 116 cm W 46 cm D 46cm H 45.67" W 18.11" D 18.11"
✂ M:	H 155 cm W 52 cm D 52 cm H 61.02" W 20.47" D 20.47"	M: H 151 cm W 46 cm D 46 cm H 59.45" W 18.11" D 18.11"
L:	H 190 cm W 52 cm D 52 cm H 74.80" W 20.47" D 20.47"	L: H 186 cm W 46 cm D 46 cm H 73.23" W 18.11" D 18.11"

	Baseplate	Wood
⚖ S:	15 kg 33.06 lbs	12 kg 26.46"
M:	18,5 kg 40.78 lbs	15,5 kg 34.17"
L:	22 kg 48.50 lbs	19 kg 41.89"

☰ Fabric, Trevira CS+ |CS, Revive 1, Clara 2, Remix 3, Velvet, Hero, Tonus 4, Memory 2

☰ Color baseplate: Black (RAL 9005)
 Optional wheels for metal baseplate only (4 pcs)

BuzziTotem Beam 3D

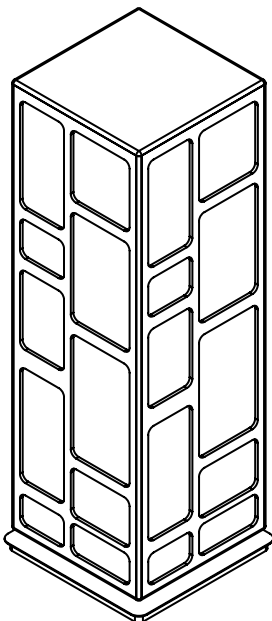

🔪 S|M|L

🌲 Filling: Acoustic foam with Plywood, MDF, Pinewood
 Baseplate: powder coated metal or Wood with plastic feet
 Pattern: 3D Frame, 3D Rib Thin, 3D Rib Thick

	Baseplate	Wood
S:	H 119 cm W 52 cm D 52 cm H 46.85" W 20.47" D 20.47"	S: H 115 cm W 46 cm D 46 cm H 61.02" W 18.11" D 18.11"
✂ M:	H 154 cm W 52 cm D 52 cm H 60.63" W 20.47" D 20.47"	M: H 150 cm W 46 cm D 46 cm H 59.06" W 18.11" D 18.11"
L:	H 189 cm W 52 cm D 52 cm H 74.41" W 20.47" D 20.47"	L: H 185 cm W 46 cm D 46 cm H 72.83" W 18.11" D 18.11"

	Baseplate	Wood
⚖ S:	15 kg 33.06 lbs	12 kg 26.46 lbs
M:	18,5 kg 40.78 lbs	15,5 kg 34.17 lbs
L:	22 kg 48.50 lbs	19 kg 41.89 lbs

☰ Fabric, Trevira CS+ |CS, Revive 1, Clara 2, Remix 3, Hero, Tonus 4, Memory 2

☰ Color baseplate: Black (RAL 9005)
 Optional wheels for metal baseplate only (4 pcs)

BuzziTotem Cylinder Flat

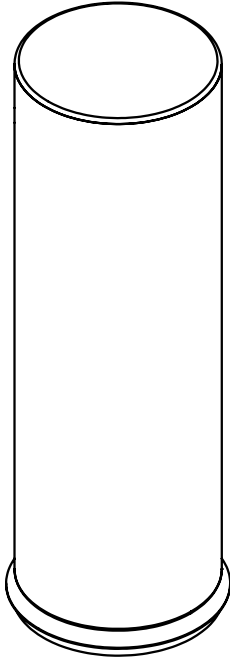

🔑 S|M|L

🌲 Filling: Acoustic foam with Plywood, MDF, Pinewood
 Baseplate: powder coated metal or Wood with plastic feet

Baseplate

S: H 120 cm Ø 52 cm
 H 47.24" Ø 20.47"

✂ M: H 155 cm Ø 52 cm
 H 61.02" Ø 20.47"

L: H 190 cm Ø 52 cm
 H 74.80" Ø 20.47"

Wood

S: H 116 cm Ø 46 cm
 H 45.67" Ø 18.11"

M: H 151 cm Ø 46 cm
 H 59.45" Ø 18.11"

L: H 186 cm Ø 46 cm
 H 73.23" Ø 18.11"



Baseplate

S: 12 kg | 26.46 lbs
 M: 15 kg | 33.06 lbs
 L: 18 kg | 39.68 lbs

Wood

S: 8 kg | 17.64 lbs
 M: 11 kg | 24.25 lbs
 L: 14 kg | 30.86 lbs

Fabrics: Fabric, Trevira CS+ | CS, Revive 1, Clara 2, Remix 3, Velvet, Hero, Tonus 4, Memory 2

⋮ Color baseplate: Black (RAL 9005)
 Optional wheels for metal baseplate only (5 pcs)

BuzziTotem Cylinder 3D

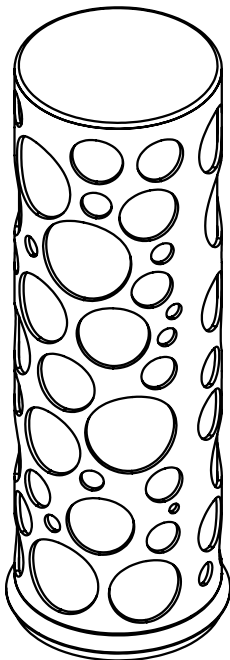

🔑 S|M|L

🌲 Filling: Acoustic foam with Plywood, MDF, Pinewood
 Baseplate: powder coated metal or Wood with plastic feet
 Pattern: 3D Rib Thin, 3D Rib Thick, 3D Leaf, 3D Bubble

Baseplate

S: H 119 cm Ø 52 cm
 H 46.85" Ø 20.47"

✂ M: H 154 cm Ø 52 cm
 H 60.63" Ø 20.47"

L: H 189 cm Ø 52 cm
 H 74.41" Ø 20.47"

Wood

S: H 115 cm Ø 46 cm
 H 45.28" Ø 18.11"

M: H 150 cm Ø 46 cm
 H 59.06" Ø 18.11"

L: H 185 cm Ø 46 cm
 H 72.83" Ø 18.11"



Baseplate

S: 12 kg | 26.46 lbs
 M: 15 kg | 33.07 lbs
 L: 18 kg | 39.68 lbs

Wood

S: 8 kg | 17.64 lbs
 M: 11 kg | 24.25 lbs
 L: 14 kg | 30.86 lbs

Fabric, Trevira CS+ | CS, Revive 1, Clara 2, Remix 3, Hero, Tonus 4, Memory 2

⋮ Color baseplate: Black (RAL 9005)
 Optional wheels for metal baseplate only (5 pcs)

Patterns

Wedge

Flat

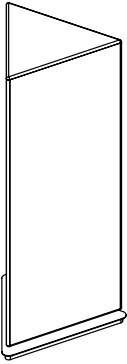

3D Rib Thin

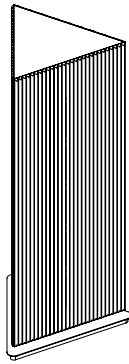

3D Rib Thick

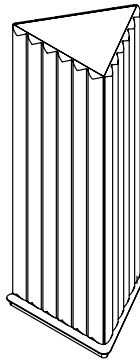

3D Tri

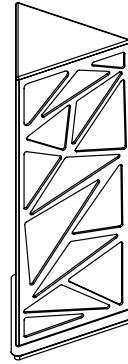

Beam

Flat

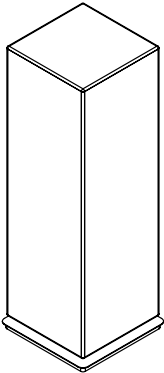

3D Rib Thin

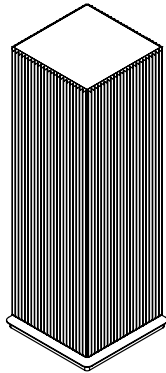

3D Rib Thick

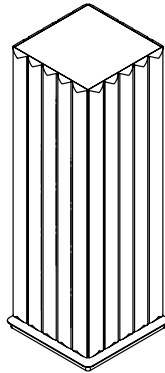

3D Frame

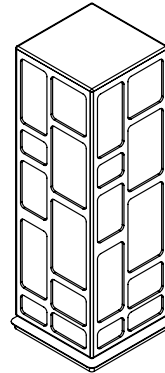

Cylinder

Flat

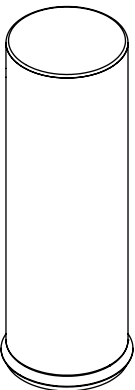

3D Rib Thin

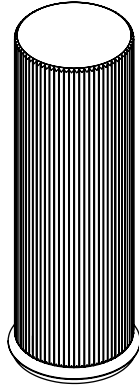

3D Rib Thick

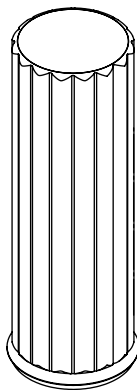

3D Leaf

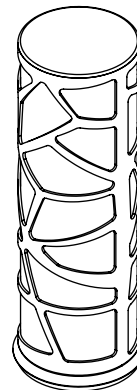

3D Bubble

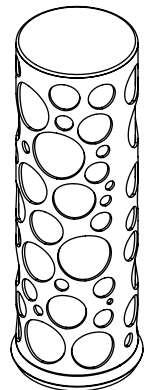

Components

Bottom

Baseplate

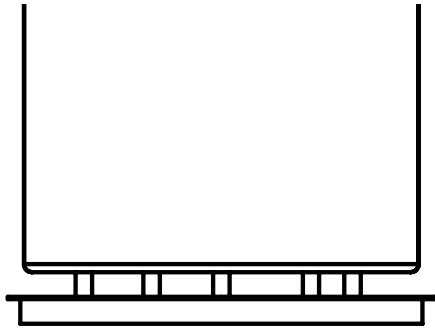

Baseplate powder coated metal
Color baseplate: Black (RAL 9005))

Wood



Bottom:
Poplar multiplex
Wedge: 3 plastic feet
Beam: 4 plastic feet
Cylinder: 5 plastic feet

Wheels (optional)

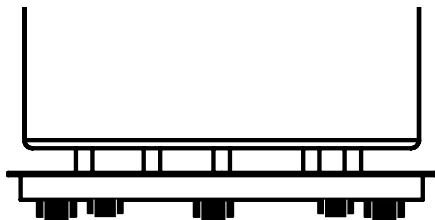

Wheels only in combination with baseplate
Wedge: 3 wheels
Beam: 4 wheels
Cylinder: 5 wheels

Fabrics

Fabric

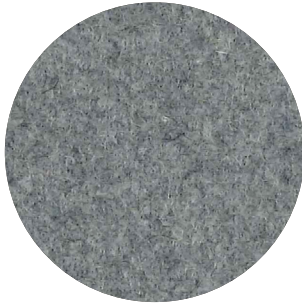

Category A

Composition 70% Recycled Wool, 25% Recycled Polyacryl,
5% Recycled Other Fabrics

Weight 405 g/m² | 11.94 oz/yd²

Abrasion resistance 40.000 Martindale, 50,000 Wyzenbeek

Flammability EU: EN 1021.1/2006 | BS EN 1021.1/2006 (cigarette).
EN 1021.2/2006 | BS EN 1021.2/2006 (match)
USA: CAL TB 117 | ASTM E84 CLASS A

Fastness to light EU: 4 | USA 4

Fastness to rubbing EU: Wet 3-4 | Dry 4-5

Fastness to crocking USA: Wet 5 | Dry 5



Trevira CS+ | CS

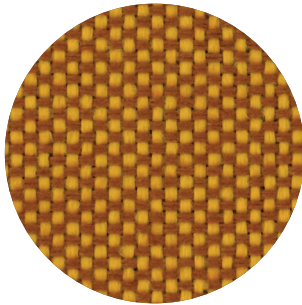

Category A

Weight 420 g/m² | 12.39 oz/yd²

Composition 100% Polyester, Trevira CS

Abrasion resistance 100.000 Martindale, 90,000 Wyzenbeek

Flammability BS 5852 part II: CRIB 5 | BS 7176 Medium Hazard
USA: CAL TB 117 | M1 | B1 | EN 1021/1-2 | C1 |
IMO Res. A652 (16)

Fastness to light EU: 6 | USA 5

Fastness to rubbing EU: Wet 4-5 | Dry 4-5

Fastness to crocking USA: Wet 5 | Dry 5



Revive 1

kvadrat

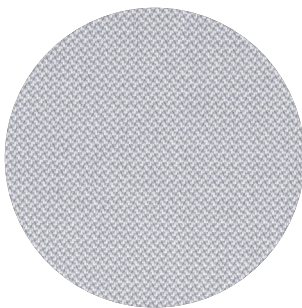

Category A

Composition 100% recycled polyester FR

Weight 430 g/lin.m

Abrasion resistance 60.000 Martindale rubs, EN ISO 12947

Flammability EN 1021-1/2 | DIN 4102 B1 | Önorm B1/Q1
UNI 9175 1IM | US Cal. Tech. Bull. 117
IMO A.652 (16)

Fastness to light Note 5-7, ISO 105-B02

Fastness to rubbing (ISO) dry 5, wet 4-5

Pilling Note 4-5, EN ISO 12945



Velvet (not for 3D)

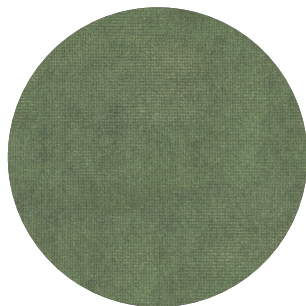

Category B
Composition 100% PES
Weight 375 g/m² | 11.06 oz/yd²
Abrasion resistance > 100.000 Martindale
Fastness to light EU: 4-5
Fastness to rubbing EU: Wet 4 | Dry 4-5
Pilling EU: 4-5

Clara 2

kvadrat

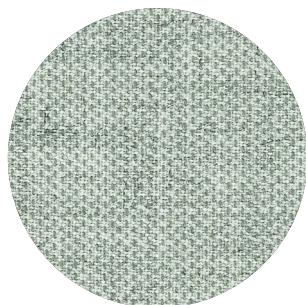

Category B
Composition 92% new wool, 8% nylon
Weight 400 g/lin.m
Abrasion resistance 80.000 Martindale rubs, EN ISO 12947
Flammability EN 1021-1/2 | BS 5852, ignition source 2-3 | DIN 4102 B2
NF D 60 013 | UNI 9175 1IM | US Cal. Tech. Bull. 117, Sec. E
NFPA 260 | IMO A.652(16)
Fastness to light Note 5-7, ISO 105-B02
Fastness to rubbing (ISO) dry 4-5, wet 4
Pilling Note 4, EN ISO 12945



Remix 3

kvadrat



Category B
Composition 90% new wool, 10% nylon
Weight 415 g/lin.m
Abrasion resistance 100.000 Martindale rubs, EN ISO 12947
Flammability EN 1021-1/2 | BS 5852 part 1
Önorm B1/Q1 | NF D 60 013 | UNI 9175, 1IM
AS/NZS 1530.3 | Cal. Tech. Bull. 117-2013
NFPA 260 | IMO FTP Code 2010:Part 8
Fastness to light Note 5-7, ISO 105-B02
Fastness to rubbing (ISO) dry 4-5, wet 4
Pilling Note 4, EN ISO 12945



Hero

kvadrat

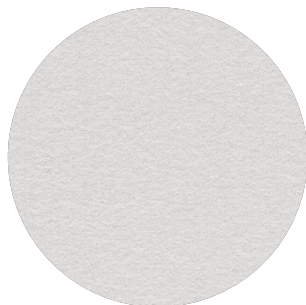

Category C
Composition 96% new wool, 4% nylon
Weight 580 g/lin.m
Abrasion resistance 45.000 Martindale rubs, EN ISO 12947
Flammability EN 1021-1/2 | DIN 4102 B2 | NF D 60 013
UNI 9175 1IM | US Cal. Bull. 117-2013 | NFPA 260
IMO A.652 (16)
Fastness to light Note 5-6, ISO 105-B02
Fastness to rubbing (ISO) dry 4-5, wet 4-5
Pilling Note 3-4, EN ISO 12945



Tonus 4

kvadrat

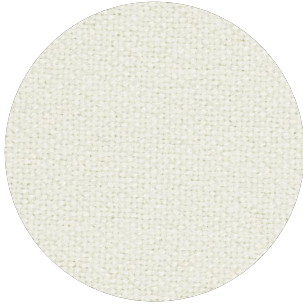

Category D

Composition 90% new wool, 10% Helanca

Weight 665 g/lin.m

Abrasion resistance 100.000 Martindale rubs, EN ISO 12947

Flammability EN 1021-1/2 | BS 5852 part 1 | DIN 4102 B2

Önorm B1/Q1 | NF D 60 013 | UNI 9175 11M

US Cal. Bull. 117-2013 | NFPA 260 | IMO A.652 (16)

Fastness to light Note 5-7, ISO 105-B02

Fastness to rubbing (ISO) dry 3-5, wet 3-5

Pilling Note 3, EN ISO 12945



Memory 2

kvadrat

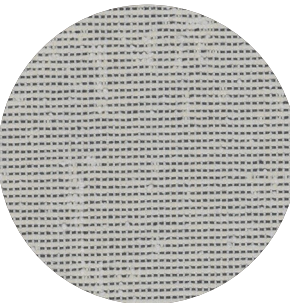

Category E

Composition 100% Trevira CS

Weight 700 g/lin.m

Abrasion resistance

35.000 rubs acc. to the Martindale method, EN ISO 12947

Flammability EN 1021-1/2 | DIN 4102 B1 | Önorm B1/Q1

NF D 60 013 | NF P 92 507 M1 | UNI 9175 11M

UNI 9177 classe 1 | US Cal. Tech. Bull. 117

IMO A.652 (16)

Fastness to light Note 5-8, ISO 105-B02

Fastness to rubbing (ISO) dry 4-5, wet 4-5

Pilling Note 4, EN ISO 12945



Dimensions

BuzziTotem Wedge Baseplate

Side

Top

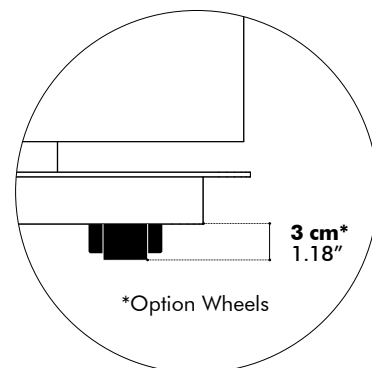
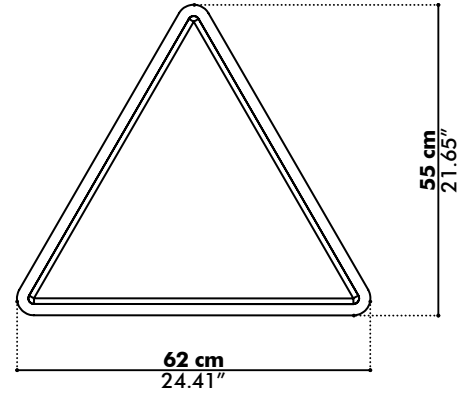
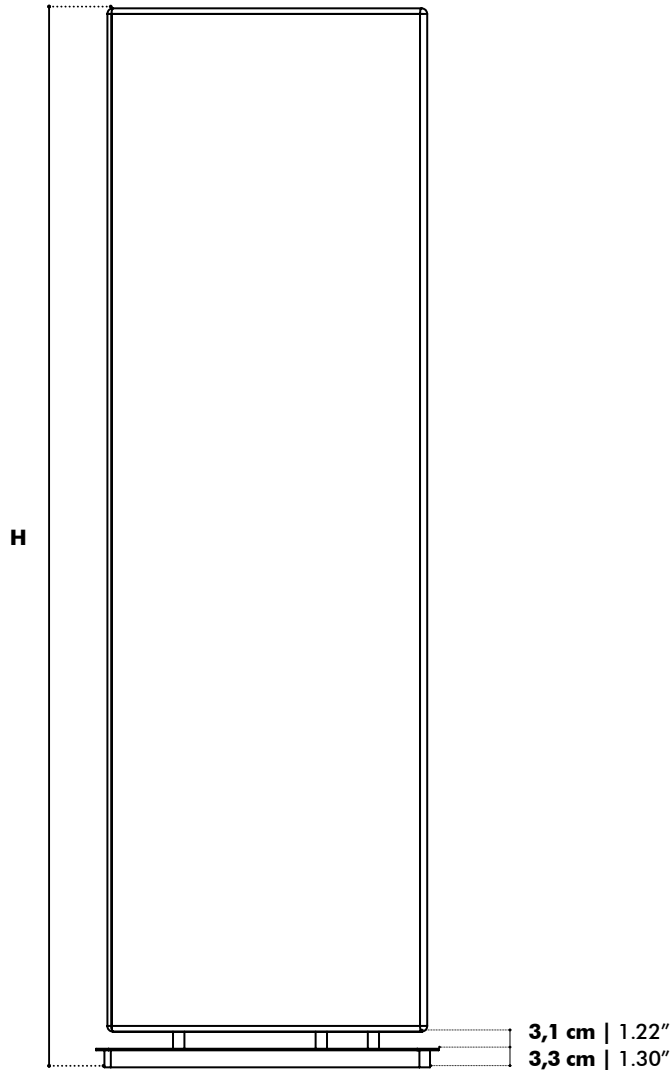

Flat	Wedge S	Wedge M	Wedge L	3D	Wedge S	Wedge M	Wedge L
H	120 cm	155 cm	190 cm		119 cm	154 cm	189 cm
	47.24"	61.02"	74.80"		46.85"	60.63"	74.41"

BuzziTotem Wedge Wood

Side

Top

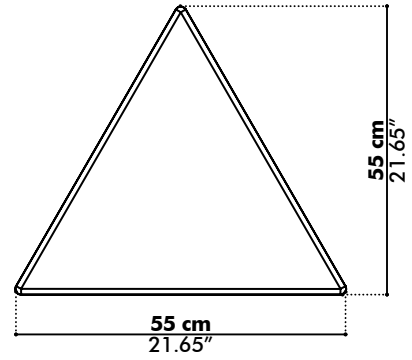
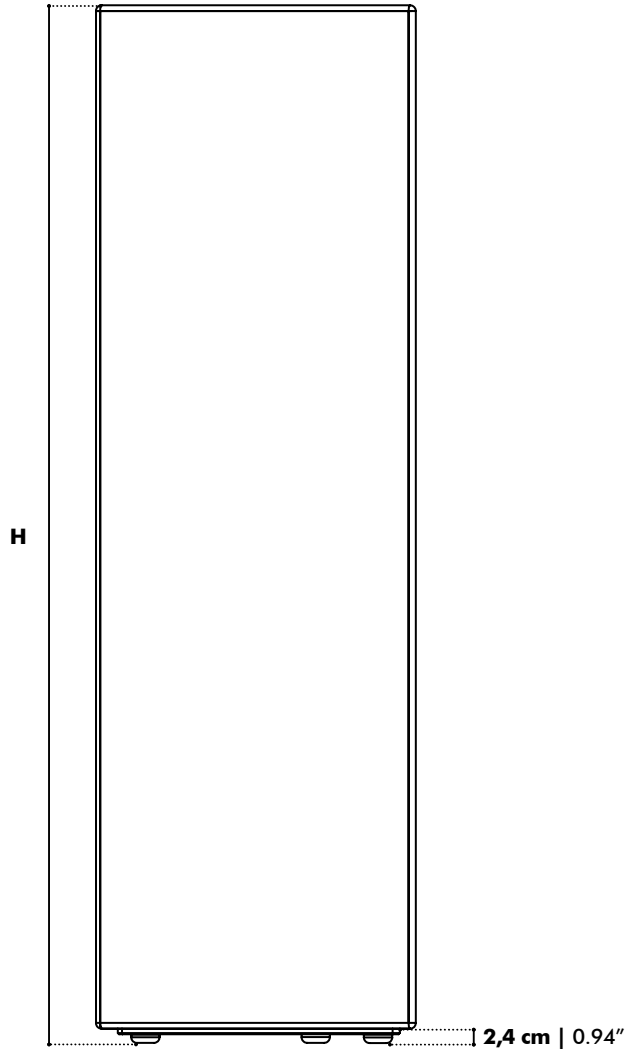

Flat	Wedge S	Wedge M	Wedge L	3D	Wedge S	Wedge M	Wedge L
H	116 cm	151 cm	186 cm		115 cm	150 cm	185 cm
	45.67"	59.45"	73.23"		45.28"	59.06"	72.83"

BuzziTotem Beam Baseplate

Side

Top

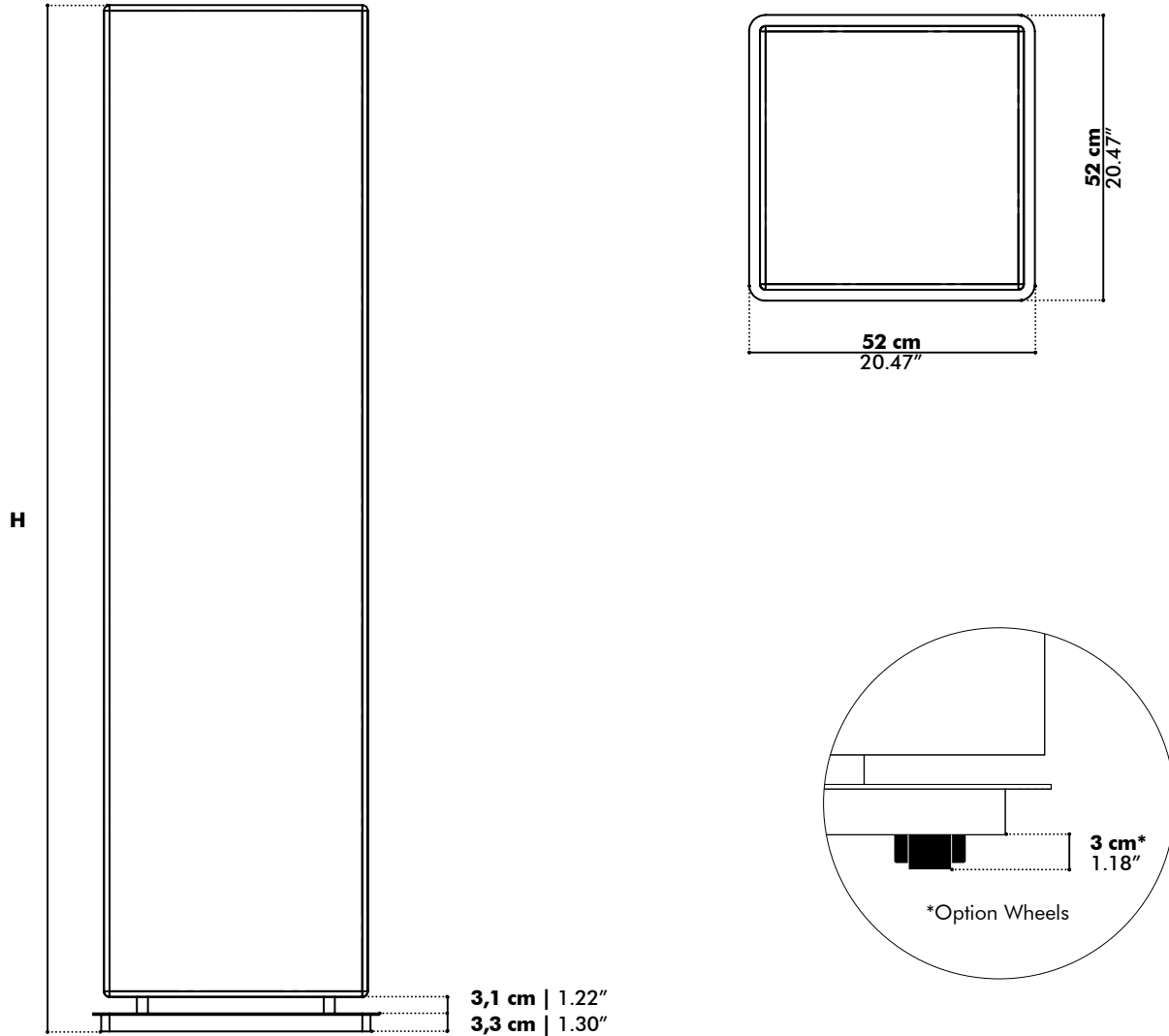

Flat	Beam S	Beam M	Wedge L	3D	Beam S	Beam M	Beam L
H	120 cm	155 cm	190 cm		119 cm	154 cm	189 cm
	47.24"	61.02"	74.80"		46.85"	60.63"	74.41"

BuzziTotem Beam Wood

Side

Top

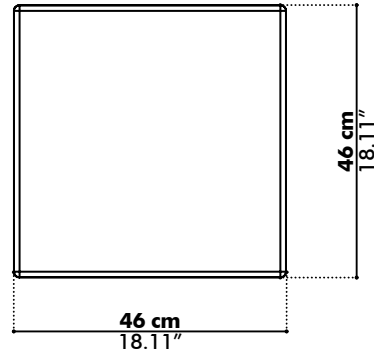
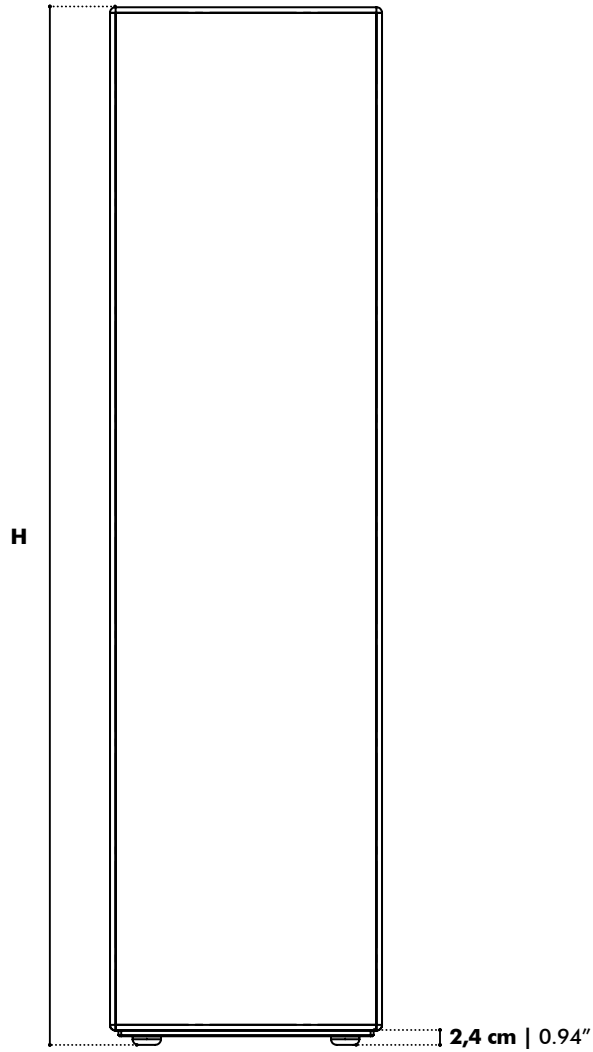

Flat	Beam S	Beam M	Beam L	3D	Beam S	Beam M	Beam L
H	116 cm	151 cm	186 cm		115 cm	150 cm	185 cm
	45.67"	59.45"	73.23"		45.28"	59.06"	72.83"

BuzziTotem Cylinder Baseplate

Side

Top

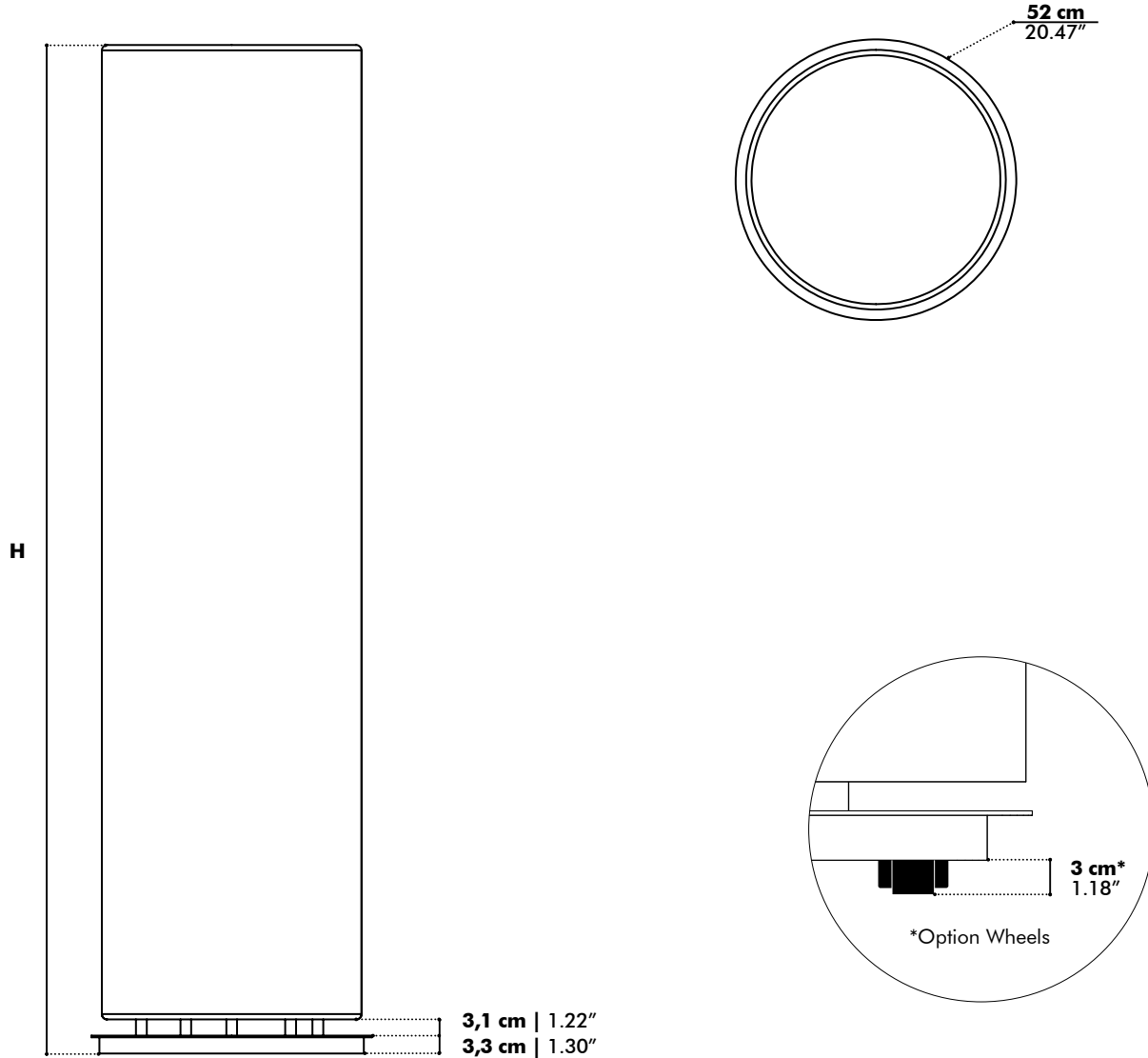

Flat	Cylinder S	Cylinder M	Cylinder L	3D	Cylinder S	Cylinder M	Cylinder L
H	120 cm	155 cm	190 cm		119 cm	154 cm	189 cm
	47.24"	61.02"	74.80"		46.85"	60.63"	74.41"

BuzziTotem Cylinder Wood

Side

Top

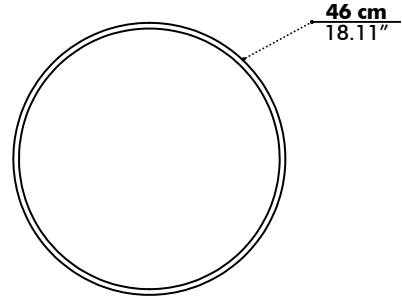
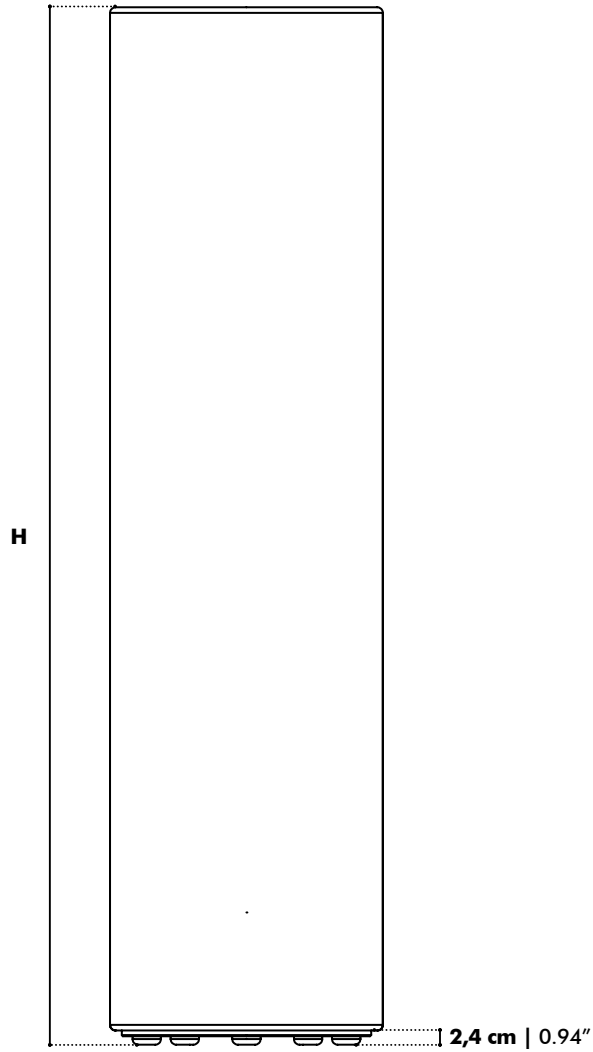

Flat	Cylinder S	Cylinder M	Cylinder L	3D	Cylinder S	Cylinder M	Cylinder L
H	116 cm	151 cm	186 cm		115 cm	150 cm	185 cm
	45.67"	59.45"	73.23"		45.28"	59.06"	72.83"

Acoustics

BuzziTotem Wedge

Equivalent sound absorption area in m² per object



Hz	Wedge S Aeq/m ²	Wedge M Aeq/m ²	Wedge L Aeq/m ²
125	0.98	1.24	1.50
250	1.70	2.14	2.60
500	1.81	2.30	2.80
1000	2.00	2.55	3.10
2000	1.96	2.49	3.00
4000	2.20	2.80	3.40

BuzziTotem Beam

Equivalent sound absorption area in m² per object

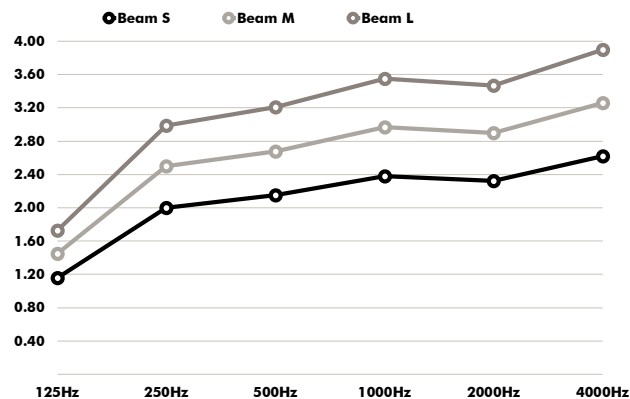

Hz	Beam S Aeq/m ²	Beam M Aeq/m ²	Beam L Aeq/m ²
125	1.16	1.45	1.73
250	2.00	2.50	2.99
500	2.15	2.68	3.21
1000	2.38	2.97	3.55
2000	2.32	2.90	3.47
4000	2.62	3.26	3.90

BuzziTotem Cylinder

Equivalent sound absorption area in m² per object

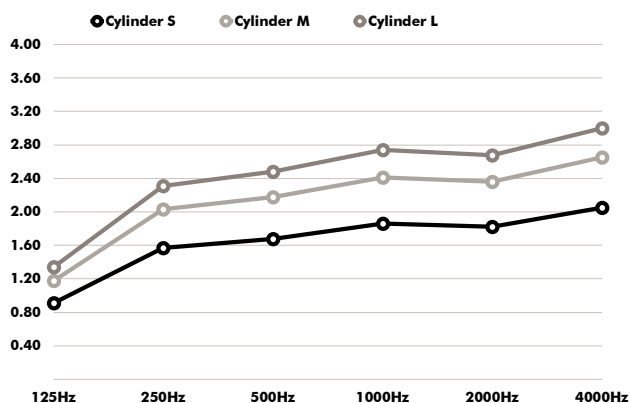

Hz	Cylinder S Aeq/m ²	Cylinder M Aeq/m ²	Cylinder L Aeq/m ²
125	0.91	1.18	1.34
250	1.57	2.03	2.31
500	1.68	2.18	2.48
1000	1.86	2.41	2.74
2000	1.82	2.36	2.68
4000	2.05	2.65	3.00